



## MEMORANDUM

DATE: June 12, 2023

TO: Planning Commission

FROM: Pierce Macdonald, Senior Planner

SUBJECT: Multifamily Objective Design Standards (MODS)

---

### AGENDA ITEM NUMBER 4

#### RECOMMENDATION:

This item reintroduces the draft Multifamily Objective Design Standards (MODS), and no action by the Commission is required on June 12, 2023. Comments on this agenda item from Commissioners and members of the public are welcomed and encouraged. City staff requests that the Commission inform staff about information or revisions needed prior to consideration of a recommendation to City Council.

#### EXECUTIVE SUMMARY:

Piedmont's current housing policy efforts began in 2019 with preparation for a Measure A-1 affordable housing funding program, and then in 2020 with authorization to pursue an SB 2 grant. In conjunction with the work to update the Piedmont Housing Element, City staff published the first draft of the Piedmont Multifamily Objective Design Standards (MODS) on October 19, 2021, and on October 6, 2022, published the revised public hearing draft of the proposed MODS document for public review and comment. The public comment period started October 6, 2022, and ended November 21, 2022. The MODS document was published to the homepage of the Piedmontishome.org website and in an electronic newsletter sent to over 1,000 households in Piedmont. On October 10, 2022, the Planning Commission heard an update about the MODS. At the close of the public comment period, City staff received three comment letters from members of the public. This report reintroduces the MODS, provides background information about the MODS, a summary of public comments, and briefing on next steps. The expected next step during the Commission's regular meeting on July 10, 2023, is for the Planning Commission to consider a recommendation that the City Council adopt the MODS.

#### BACKGROUND:

As referenced above, under an SB 2 grant, the City's housing staff and consultants have prepared a proposed new housing program and procedure in compliance with State law consisting of objective design standards for multifamily and mixed-use development (MODS). Objective design standards are defined in Government Code Sections 65913.4 and 66300(a)(7) as standards that "involve no personal or subjective judgment by a public official and are uniformly verifiable by reference to an external and uniform benchmark or criterion available and knowable by both the development applicant or proponent and the public official before submittal." Objective design standards may include portions of general plans, specific plans, zoning codes, overlay zones,

subdivision requirements, and landscaping and other land development regulations.

A second new housing program to develop new incentives for rent-restricted ADUs was also funded by the SB 2 grant. The ADU incentives program will be the subject of a future Planning Commission meeting.

Community outreach for the SB 2 funded work to date has included the following activities and events:

- Stakeholder interviews, consisting of 34 community members, were conducted in November 2020.
- The Piedmontishome.org website, FAQs, and online housing survey were launched March 2021. The survey included questions related to design preferences.
- The Housing Advisory Committee met on May 19, 2021, to review the results of public engagement, the project overview, the Piedmont community’s multifamily design preferences, introduction to strategies to affirmatively further fair housing, and introduction to site inventory and testing.
- On June 15, 2021, the Housing Advisory Committee met to review project objectives, community outreach results on ADUs, and an introduction to options for designs and incentives.
- On June 21, 2021, the City Council held a public meeting to consider the guiding principles of the SB 2-funded new housing programs. At the conclusion of public comment on the item, the Council adopted the following guiding principles:

**1. Support equitable distribution of affordable units across the City.** A diversity of housing choices, including new affordable multi-family housing, new mixed-income multi-family housing, new residential mixed-use development, converted units, ADUs, and Junior ADUs, should be considered throughout the City’s neighborhoods, corridors, and zoning districts.

**2. Promote and enhance community design and neighborhoods.** Infill development should be compatible with the neighborhood context. Development and design standards should ensure that new construction enhances the area in terms of building scale, placement, and design; and is sensitive to impacts on the neighborhood, including impacts related to sunlight access, privacy, and roadway access. Each building must exhibit high-quality design and play a role in creating a better whole.

**3. Remove barriers to development and access to housing through clear and objective standards.** Development standards and procedures should guide development that is equitable and feasible and that lead applicants through procedures that are transparent and predictable.

**4. Facilitate the development of new housing units through strategic partnerships between the City and the broader community.** Partnerships to facilitate development include striving to reach community consensus for desired designs; and achieving

community support for new incentives, standards, and tools to meet housing goals.

**5. Social equity.** Work with the Community to proactively facilitate greater social equity by considering City incentives and programs that will enable new homes and apartments for a range of income levels, creating opportunities for all persons regardless of race, religion, ethnic background, or financial ability.

- On September 19, 2021, City officials and staff presented the approach for the proposed MODS designs to the Piedmont community at a booth at the Piedmont Harvest Festival.
- On October 21, 2021, the City hosted a community workshop on the Zoom platform along with the publication of the public review draft of the MODS document. The community workshop presented the purpose of objective design standards and how the MODS have been prepared in order to maintain the excellence of Piedmont’s existing architecture and setting, comply with State law, and ensure a degree of certainty in the design of multifamily and mixed-use buildings. The certainty or predictability of design benefits Piedmont community members, as well as housing developers. An illustrative concept drawing from the workshop is provide below. A link to the Community Workshop video recording is included as Attachment C.

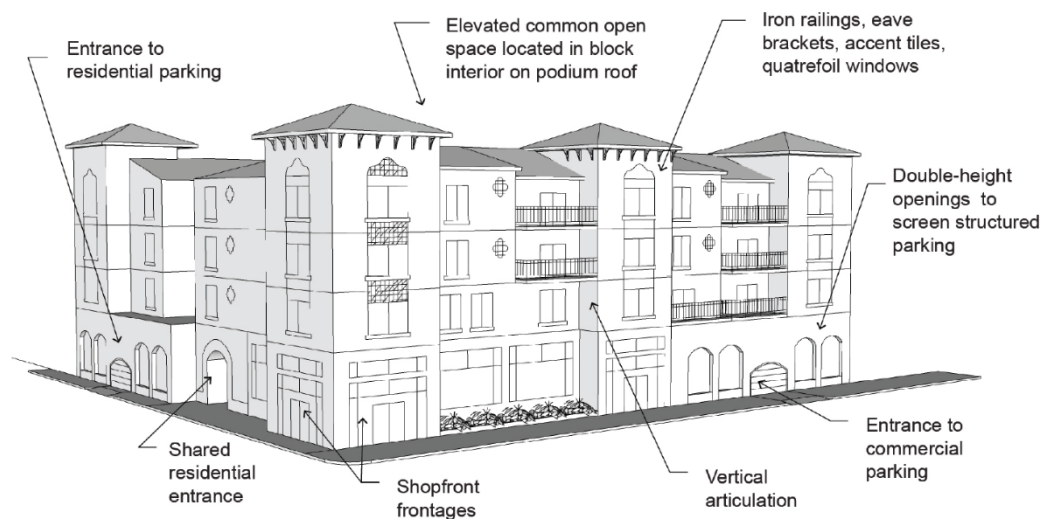

*Partial illustrative design concept*

- On November 8, 2021, City staff gave an informational report about the MODS at a public meeting of the Planning Commission held on the Zoom platform.
- The public comment period for the draft MODS document lasted from October 19 to November 19, 2021. Approximately 16 comment letters and emails were received by staff. Comments are included as Attachment B.
- On March 15, 2022, City staff presented an informational report about the City’s housing policy work, including the MODS, to the Housing Advisory Committee. A link to the meeting video is included as Attachment E.
- The draft MODS program began to be incorporated into the Piedmont 6<sup>th</sup> Cycle Housing Element and public engagement for the Housing Element update process. In particular, the

draft MODS program aligns with draft Housing Element program 4.R, Permit Streamlining and with other programs to remove barriers to multifamily development in Piedmont's zoning districts. Public engagement for the City's housing policy efforts has included monthly reports to the Planning Commission, a presentation to the Housing Advisory Committee on March 15, 2022, presentations to the Park Commission and Recreation Commission in Spring 2022, two live informational community webinars hosted by staff, and three City Council meetings (June 20, 2022, and August 1, 2022).

- On October 6, 2022, the current draft MODS document was released for public comment, and on October 10, 2022, the Planning Commission heard an update on the draft MODS from City staff.
- On March 20, 2023, the City Council adopted the Piedmont 6<sup>th</sup> Cycle Housing Element, which included Program 4.R, Permit Streamlining, and others.

At this time, the City's Planning Division staff and consultants have begun implementing the 6<sup>th</sup> Cycle Housing Element, while working with the California Department of Housing and Community Development (HCD) to provide the information needed by HCD to certify the Housing Element. Subsequent to this reintroduction, City staff are preparing to bring the MODS forward for a Planning Commission recommendation on July 10<sup>th</sup>.

#### ANALYSIS:

Objective design standards, rather than discretionary standards, are mandated by State law, including SB 35, SB 330, and others, in effect starting January 1, 2018. They are intended to streamline the review of multifamily and mixed-use housing, which is often a more affordable housing type than single-family houses, duplexes, and triplexes. If a development application is consistent with the objective design standards and meets other eligibility criteria, the City may be required by State law to approve the development application without a public hearing, neighbor comments, or CEQA review. For these reasons, the draft MODS document has been developed to give the community a good deal of predictability in the design of new multifamily and mixed-use development, and the MODS include measures to reduce loss of privacy and other impacts on surrounding single-family properties.

The primary differences between the draft MODS, which was presented to the Piedmont community on October 21, 2021, and the draft published October 5, 2022 (included as a link with this staff report as Attachment A), are the changes made in response to public comments. A list of substantive changes is provided below:

1. The MODS design program and the ADU Incentives program are formatted as two separate documents.
2. The MODS now includes a glossary of terms, which can be amended as needed to help interpret the standards as they are applied to actual development applications.
3. Technical standards, such as the areas of allowed blank walls, the height of the finish floor above the sidewalk, gutters on the exterior of buildings, buffers between private and common open spaces, balconies, porches, and building frontages, have been adjusted based on public comment in order to better align them with construction practices.



Balconies and porches are no longer required to be integrated into building recesses and overhangs and may project out from the building façade in a cantilevered design.

4. Windows may have a recess of a minimum of 2 inches from the outer wall plane, instead of the previous standard requiring both 2-inch exterior trim and 2-inch recess. In order to provide clarity in the requirements, the draft Piedmont MODS document requires that a minimum of 50 percent of windows in a multifamily building must have divided lite design and all primary windows of the residential portion of a mixed-use multifamily building must have a divided lite design.
5. Standards for roof decks have been expanded and new standards for backflow preventers and public utilities have been added.
6. Building entrance types have been clarified and the prohibition on exterior staircases to the entrances of second-story units has been relaxed in order to allow them. Exterior staircases to units above the second floor continue to be prohibited.
7. Allowed building materials have been amended to include standing seam metal roofing, and the draft MODS was amended to clarify that flat membrane roofs surrounded by a parapet are permitted. A roofline balustrade is no longer a design feature.
8. The draft MODS includes language intended to incentivize roof features that result in 0 net energy consumption in new buildings.
9. The draft MODS includes a parking reduction program for both residential and non-residential uses supported by a parking study that confirms that complementary uses lower the need for parking.
10. Terms that were ambiguous have been removed from the text, such as “decorative,” as they introduced discretion in the application of the design standards.

The feasibility analysis completed in 2021 has not been changed. It continues to show that a residential density of at least 80 dwelling units per acre would be necessary for a multifamily development proposal to be financially feasible. This feasibility analysis is informational only and will not be a component of the MODS document when it is prepared for City Council review.

Since the draft MODS document was published on October 6, 2022, City staff received several suggested changes and comments in three letters received from members of the public. Public comments received between October 6 and November 22, 2022, are included as Attachment F. Based on this feedback, City staff suggests the following changes to the text and diagrams of the draft MODS (Attachment A):

1. Pages 5 and 17, create a dimension at which upper stories of multifamily and mixed-use buildings must have a step-back when adjacent to single-family residence in Zone A. For example, if a building is built at the step-back dimension that would normally be required, then no further step-back measured from the lower facades would be applicable.
2. Amend standard 4., page 10, so that the graphic is consistent with the text for the height of finish floor above grade at the sidewalk. Finish floor should be a minimum of 18 inches

above the grade at the sidewalk (not 24 inches as shown on the diagram).

3. Remove the option on page 21 for an arcade feature at the ground floor for mixed-use development.
4. Amend the standard for ground floor leasable commercial space in mixed-use buildings on page 25 to have a minimum depth of 50 feet for 50% of the space ***or a minimum of 30 feet of width, whichever is bigger*** (change in bold *italics*).
5. Pages 23 and 24, amend standards for bicycle parking and remove requirement for showers for bicyclists. The recommended revisions correct the clearance to 5 feet and 2 feet of horizontal clearance between bicycle parking spaces and adjacent auto parking spaces and structures on page 23.

Some suggested changes to the draft MODS document are not recommended for incorporation at this time because the standards are meant to build predictability into an objective and ministerial process, required by State law, by describing the types of development projects that are exempt from discretionary review. In addition, many community workshops and other forms of public engagement resulted in the proposed standards. Some suggested changes to standards would require more public input, such as suggestions to anticipate needs of EV bicycle riders, long-tail bicycle parking standards, and short-term bicycle parking near building entrances. Some suggested changes from members of the public would introduce uncertainty in the desired design elements and negate the ability of staff to streamline City review. Others such as suggested definitions of common architectural elements could increase the complexity of the standards.

However, it is likely that some desired designs are not yet anticipated in these draft standards. The draft MODS are intended to be a “living document” that is expected to be revised and improved over time. As developers and property owners approach the City of Piedmont with development concepts, changes to the MODS may be brought forward for Planning Commission and City Council consideration.

In addition, building designs that are not consistent with the draft MODS may be acceptable and approved through other processes, such as Piedmont’s discretionary design review process, as development and construction applications are reviewed today.

#### CEQA:

Starting in 2021, City staff focused the scope of the MODS program on exterior design elements such as exterior materials, roof forms, windows, doors, and building features. The proposed Multifamily Objective Design Standards (MODS program), included as Attachment A, does not change the underlying development potential of property in any zone in Piedmont. As such the adoption of the proposed MODS is not subject to the California Environmental Quality Act (CEQA) because it is not a project within the meaning of CEQA and it can be seen with certainty that there is no possibility that the adoption of Multifamily Objective Design Standards may have a significant effect on the environment. (Public Resources Code section 21065; CEQA Guidelines, 14 Cal. Code of Regs. Sections 15061(b)(3), 15378.)

NEXT STEPS:

Objective design standards, rather than discretionary standards, have been required by State law since 2018. Under the terms of the SB 2 grant, the City must adopt a MODS program by September 2023 or lose this grant funding. The proposed MODS program anticipates zoning changes, such as changes to permitted residential density and height limits, that are expected to be considered with the implementation of the 6<sup>th</sup> Cycle Housing Element.

The proposed MODS will be brought forward for Planning Commission review by July 2023, and City Council review by August 2023. Public comment is accepted throughout the development of the SB 2 new housing programs. Staff requests Planning Commission consideration and comments about the types of information and possible revisions to the MODS that may be needed in order for the Planning Commission to be able to make a recommendation to the City Council.

ATTACHMENTS:

- A. Pages 8-48 Draft Piedmont Multifamily Objective Design Standards, October 2022 (MODS)
- B. Pages 49-63 Public Comment, received by November 19, 2021
- C. *Online* October 21, 2021 New Housing Programs Community [Workshop Presentation](https://static1.squarespace.com/static/5fdea2c9d61098631976bacc/t/61774138e486895f969f174d/1635205454513/LWC_Piedmont_Community+Event+%234_102121_Presentation.pdf)  
[https://static1.squarespace.com/static/5fdea2c9d61098631976bacc/t/61774138e486895f969f174d/1635205454513/LWC\\_Piedmont\\_Community+Event+%234\\_102121\\_Presentation.pdf](https://static1.squarespace.com/static/5fdea2c9d61098631976bacc/t/61774138e486895f969f174d/1635205454513/LWC_Piedmont_Community+Event+%234_102121_Presentation.pdf)
- D. *Online* October 21, 2021, New Housing Programs [Video](https://piedmont.granicus.com/player/clip/2430?view_id=3&redirect=true&h=e53a37dff0cc858aefb47b98f2b6b69f)  
[https://piedmont.granicus.com/player/clip/2430?view\\_id=3&redirect=true&h=e53a37dff0cc858aefb47b98f2b6b69f](https://piedmont.granicus.com/player/clip/2430?view_id=3&redirect=true&h=e53a37dff0cc858aefb47b98f2b6b69f)
- E. *Online* March 15, 2022, Housing Advisory Committee Meeting [Video](https://piedmont.granicus.com/player/clip/2497?view_id=3&redirect=true&h=f9c34d1545008a44f5c2ad29cc191360)  
[https://piedmont.granicus.com/player/clip/2497?view\\_id=3&redirect=true&h=f9c34d1545008a44f5c2ad29cc191360](https://piedmont.granicus.com/player/clip/2497?view_id=3&redirect=true&h=f9c34d1545008a44f5c2ad29cc191360)
- F. Pages 64-74 Public comments received October 6, 2022, to November 21, 2022.
- G. Pages 75-89 PowerPoint presentation, prepared by staff for the June 12, 2023, Planning Commission meeting.
- H. Pages 90-92 October 10, 2022 Planning Commission Meeting Minutes (excerpt)
- I. *Online* October 10, 2022 Planning Commission Meeting [Video](https://piedmont.granicus.com/player/clip/2601?view_id=3&redirect=true&h=d4f3ce0ae7918d93aa436ad10ae337f7)  
[https://piedmont.granicus.com/player/clip/2601?view\\_id=3&redirect=true&h=d4f3ce0ae7918d93aa436ad10ae337f7](https://piedmont.granicus.com/player/clip/2601?view_id=3&redirect=true&h=d4f3ce0ae7918d93aa436ad10ae337f7)



# City of Piedmont Multi-family Objective Design Standards

Hearing Draft | October 2022

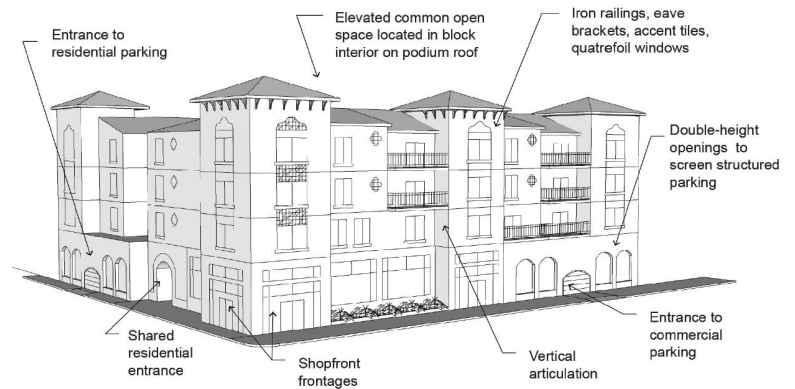

*Prepared for:*

City of Piedmont  
120 Vista Avenue  
Piedmont, CA 94611

*Prepared by:*



Lisa Wise Consulting, Inc.  
870 Market Street, Suite 977  
San Francisco, CA 94102



Open Scope Studio  
1776 18th Street  
San Francisco, CA 94107

*This page intentionally left blank.*

# Table of Contents

<b>1</b>	<b>Overview.....</b>	<b>3</b>
	In This Document .....	3
	Next Steps.....	4
<b>2</b>	<b>Objective Design Standards .....</b>	<b>5</b>
	Multi-family Residential Design Standards .....	5
	Commercial and Mixed-Use Design Standards.....	17
<b>3</b>	<b>Terms.....</b>	<b>31</b>
<b>4</b>	<b>Test Site Massing Studies.....</b>	<b>33</b>
	Zone D Civic Center Subarea Test Site.....	33
	Zone D Grand Avenue Subarea Test Site .....	35
	Test Site Feasibility .....	37



*This page intentionally left blank.*

# 1 Overview

In the fall of 2020, the City of Piedmont initiated the **Piedmont Multi-family Objective Design Standards and ADU Incentives** programs project. Funded by an SB 2 Planning Grant, these programs are part of the larger City-led “Piedmont is Home” campaign to reach out the community, to consider creative ways the City can help address the region’s housing crisis, and to make Piedmont an even more inclusive place to call home.

The **Multi-family Objective Design Standards and Accessory Dwelling Units (ADU) Incentives** programs seek to aid this effort by removing barriers for multi-family and ADU development in Piedmont. The programs support the equitable distribution of affordable units across the City and ensures that future multi-family and ADU development will preserve and enhance community character. Specifically, the programs address design and feasibility of multi-family residential and residential mixed-use development, accessory dwelling units (ADUs), and Junior ADUs (JADUs) through community-informed design standards and prototype plans. Following a community outreach campaign in the spring of 2021 that included a community-wide survey and two public meetings, the City and consulting team developed material for public review. Following public review, the planning team developed the material in this document for review by the City’s decision-making bodies.

## In This Document

This document includes the following parts:

- **Part 2, Objective Design Standards**, includes two sections: recommended design standards for multi-family development and recommended design standards for residential mixed-use development. The new sections establish design requirements to ensure that development is consistent with the character of, and compatible in scale with, existing Zone C and Zone D neighborhoods. To reflect the community’s design priorities and support predictability of design, the standards promote development in a generally preferred design. Consistent with State housing legislation, projects that comply with the Code’s objective development and design standards may undergo administrative review only. As an exception to the process, any projects that do not comply with the objective design standards may voluntarily choose a discretionary Design Review process.
- **Part 3, Test Site Studies** shows the objective design standards on two hypothetical Zone D “test sites” – one in the Grand Avenue Subarea and one in the Civic Center subarea. The test site massing studies represent just one possible expression of the objective design standards on each test site. Following the massing studies, Chapter 3 provides a summary of the economic feasibility of the two massing studies under three scenarios:
  - A base case scenario;
  - A density bonus scenario; and
  - A project that includes 50 percent affordable housing units.

The focus of the test site studies is the design (aesthetic) standards; however, the test site massing also shows possible changes to basic Zone D development standards such as height, FAR, and density. While the visualizations and feasibility study assume that such changes to the basic development

standards will be needed to achieve the City's goal of facilitating housing affordability, those changes are for future study only.

The ADU prototype plans and the recommended incentives to facilitate equitable distribution of affordable units across the City through the construction of ADUs and Junior ADUs are provided separately.

## Next Steps

Review and adoption of the Multi-family Objective Design Standards is anticipated in the fall/winter of 2022.

The work of this project will inform the ongoing efforts as Piedmont updates the Housing Element of the City's General Plan to meet the requirements of State law. The findings of the Piedmont Multi-family Objective Design Standards and ADU Incentives programs project will be used in consideration and identification of suitable sites for housing in the City.

These recommendations will ultimately allow for a streamlined approval of housing that is affordable to both owner and renter households at all income levels on a range of sites throughout the City. This includes all sites that are zoned to allow residential uses; sites that are publicly-owned; and vacant parcels. In conjunction with the Housing Element update, State law mandates that the City must support and actively facilitate affordable multi-family development on sites that are between 0.5 acres and 10 acres in size that permit residential uses at a density of at least 20 du/ac. These objective standards will assist Piedmont in meeting this mandate.

# 2 Objective Design Standards

## Multi-family Residential Design Standards

### A. Building Envelope Design.

#### 1. Upper-story Step-backs.

- a. Along the front and street side façade, the fourth story must be stepped back a minimum 5 feet from the ground floor façade.
- b. Along the interior side and rear façade, when abutting Zone A, the third and fourth story, or more, must be stepped back a minimum 5 feet from the ground floor façade.

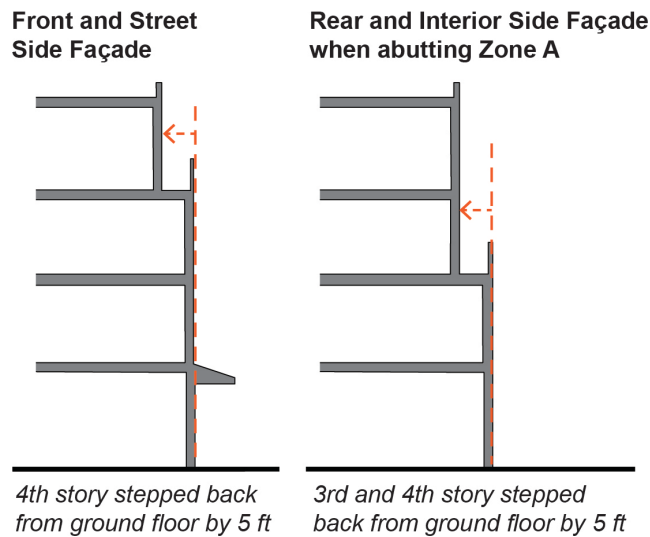

#### 2. Building Placement.

- a. *Frontage.* A minimum 70% percent of ground-floor building frontage must be built at or within 18 inches of the front setback to create a continuous street wall.
- b. *Corner Lot.* At street corners, buildings must be placed at the street yard setback lines and for a minimum 25 feet distance from the intersecting front and street side setback lines.

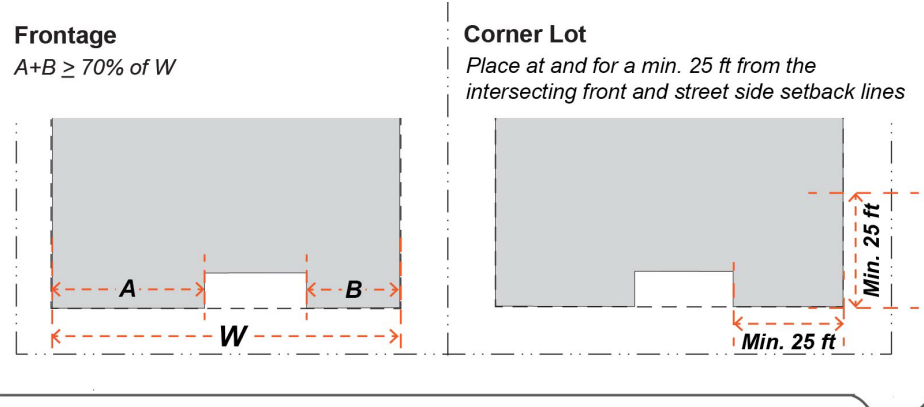

- 3. **Building Massing Abutting Zone A.** Building façade planes facing and abutting properties in Zone A may not exceed 35 feet in width without a break a minimum 6 feet depth.

#### 4. Privacy.

- a. *Outdoor Habitable Space.* Balconies, decks, and other habitable outdoor spaces are not allowed on any upper-story facades facing and abutting lots in Zone A.
- b. *Balcony and Deck Placement.* Primary living spaces located along a side setback shall orient balconies and decks towards the front and rear of the building.
- c. *Privacy and Window Placement.* Windows to primary living spaces within 10 feet of or facing a side setback or within 25 feet of and facing another unit on-site must:
  - i. Be angled away from the adjacent side setback line a minimum of 30 degree, measured from a line perpendicular to the side setback line;
  - ii. Have a minimum sill height of 42 inches from the finished floor; or
  - iii. Use permanently translucent or “frosted” glazing.

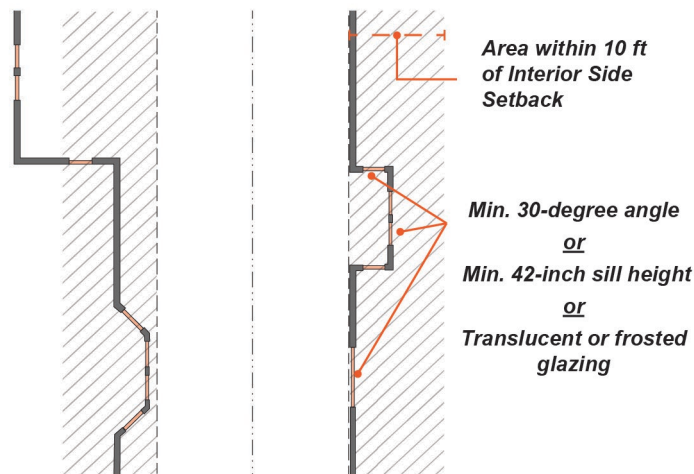

#### B. Building Design.

##### 1. Street-Facing Building Articulation and Façade Bays.

- a. *Vertical Articulation.*
  - i. Building facades up to 45 feet in length along a public right-of-way must incorporate one of the following:
    - (a) Window bays a minimum 2 feet in depth from building façade every 10 horizontal feet.
    - (b) Recesses a minimum 2 feet in depth from building façade every 10 horizontal feet.
    - (c) Porches or decks over a minimum of 25 percent of the façade.
  - ii. When a building façade exceeds 45 feet in length along a public right-of-way, it must be separated into façade bays no greater than 30 feet in width defined by a recess a minimum of 2 feet in depth and at least one of the following strategies:
    - (a) Change in roof parapet height or shape of at least 6 feet.
    - (b) Change in roof form and type (e.g. flat pitch roof to gable).

- (c) Change in building height, minimum 8-foot difference

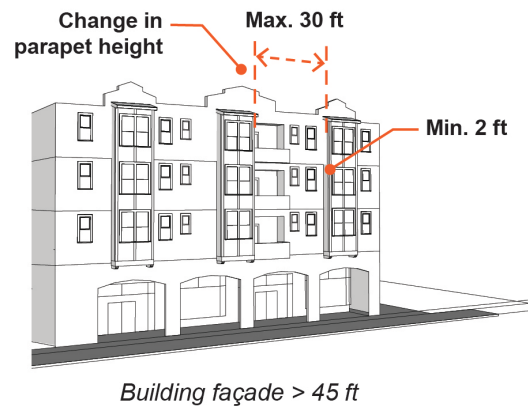

- b. *Bay Articulation.* The eave or roof form of a recessed façade bay shall be no higher than the those of bays not recessed.
- c. *Townhouses/Rowhouses.* In townhouse and rowhouse development types, facades of adjacent attached units must be staggered or off-set a minimum of 12 inches to avoid monotony in design.

## 2. Roof Form and Design.

- a. *Allowed Roof Forms.* Roof forms shall be limited to:
- i. Hipped
  - ii. Gable
  - iii. Dormers, which may not exceed 8 feet in length.
  - iv. Parapet and flat membrane roofing. Parapet segments may not exceed 25 feet in length without interruption in height or form.
  - v. Roof decks that are enclosed on the sides and rear, either partially or completely, provided the deck and deck occupants are not visible from the right-of-way or adjacent single-family property within 300 feet.
- b. *Pitch.* The pitch of the roof must be 3:12 to 5:12 ratio. Flat roofs with parapet are also permitted.
- c. *Eaves.* Where eaves exceed 18 inches in depth, exterior brackets or beams are required.
- d. *Form and Design.* Solar roofs and other Building Integrated Photovoltaic (BIPV) roof designs are exempt from these roof form standards if needed to achieve a net zero energy consumption result on site.

## 3. Building Entries.

- a. *Ground Floor Entrances.*
- i. Shared entrances must be located on the front of the building and must face a public right-of-way. Entrances are limited to a minimum 2 per facade facing and abutting the public right-of-way or 1 for every 20 housing units per facade facing the public right-of-way, whichever is greater, in Zone D.
  - ii. Individual entrances must face either a public right-of-way, an internal access drive, or a shared forecourt.
- b. *Upper Floor Entrances.* Exterior stairs to entrances to upper floor units above the second floor are not permitted.
- c. *Frontage Types.* Building frontages must take one of the following forms:



- i. Shared landscaped forecourt with dimensions as indicated below:
  - (a) Forecourt depth: Minimum 15 feet
  - (b) Forecourt width: Minimum 15 feet
  - (c) Ratio of forecourt width-to-height: Maximum 2:1
  - (d) Entrance maximum 3 feet above level of forecourt.

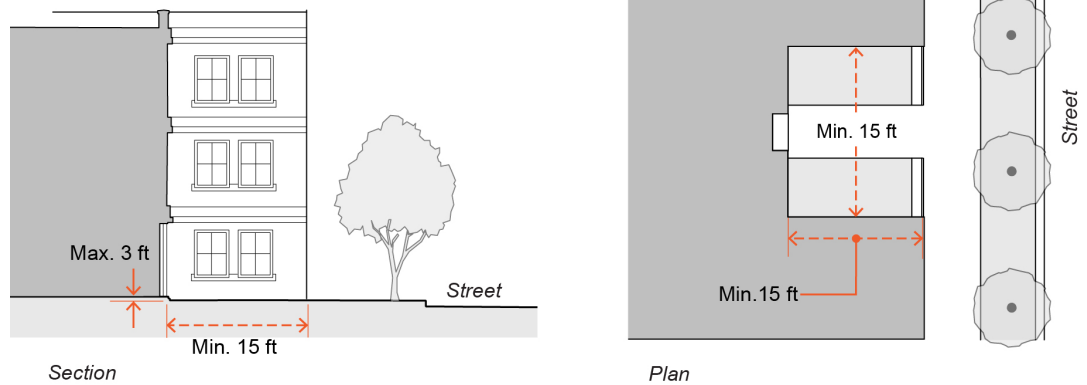

- ii. Shared entrance forecourt level above or below sidewalk: Shared or individual terrace frontage with dimensions as indicated below:
  - (a) Terrace depth: Minimum 8 feet
  - (b) Terrace width: Minimum 15 feet. Maximum 120 feet
  - (c) Distance of terrace between stairs: Maximum 50 feet
  - (d) Terrace level above sidewalk: Minimum 18 inches, maximum 5 feet

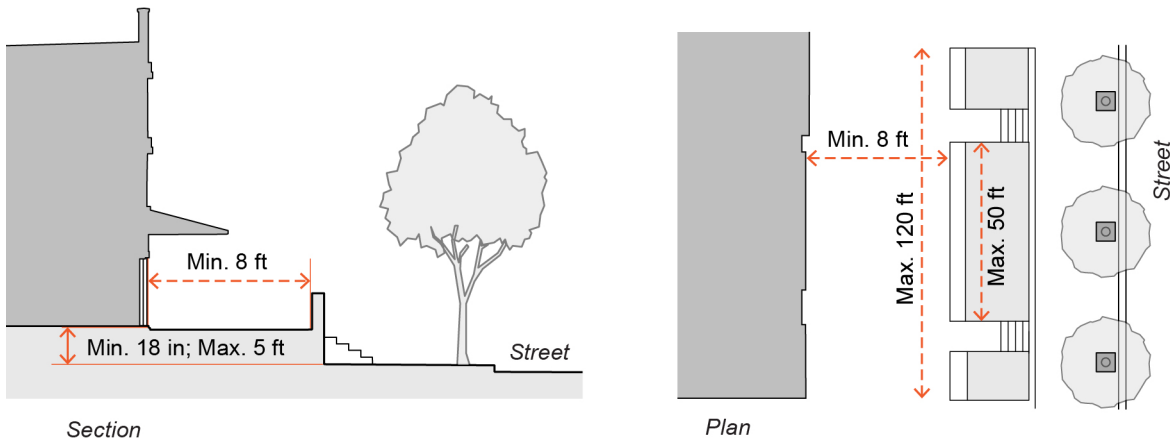

- iii. Entrances for individual units with covered dooryard frontages with dimensions as indicated below:
  - (a) Dooryard width: Minimum 6 feet
  - (b) Dooryard depth: Minimum 4 feet, maximum 8 feet

- (c) Dooryard overhead projection depth: Maximum 6 feet
- (d) Dooryard clear height: Minimum 8 feet
- (e) Dooryard wall/planter/fence height: Maximum 3 feet
- (f) Not permitted in Zone D.

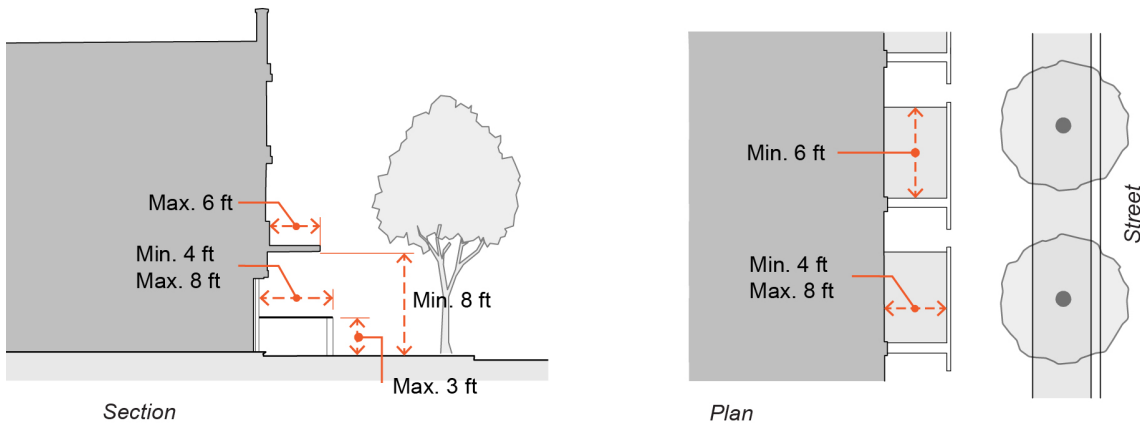

iv. Individual covered stoop frontages with dimensions as indicated below:

- (a) Stoop clear height: Minimum 8 feet
- (b) Stoop height above sidewalk: Minimum 18 inches
- (c) Stoop width: Minimum 4 feet, maximum 8 feet
- (d) Stoop depth: Minimum 4 feet, maximum 8 feet
- (e) Stoop entry recession: Minimum 6 inches, maximum 6 feet.
- (f) Not permitted in Zone D.

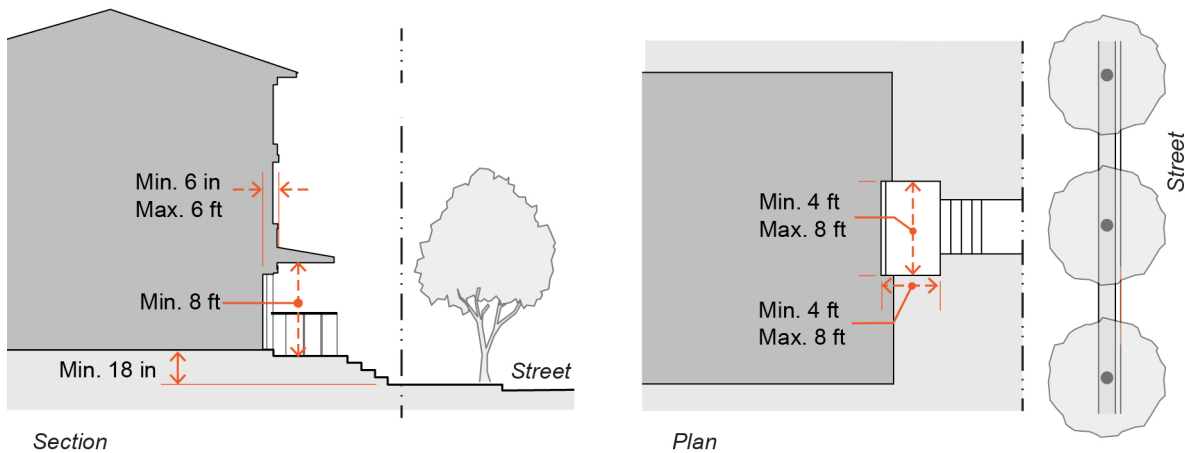

d. *Forecourt.* Forecourts must:

- i. Be visible from and linked to abutting public rights-of-way by a clear, non-combustible accessible path of travel;
  - ii. Be enclosed on at least three sides by buildings; and
  - iii. Remain open to the sky (arbors and trellises are allowed).
- di. *ADA Accessibility.* All frontages must comply with ADA accessibility requirements.

4. **Ground Floor Finish Floor Elevation.** The ground floor finish floor elevation must be minimum 18 inches above sidewalk elevation.

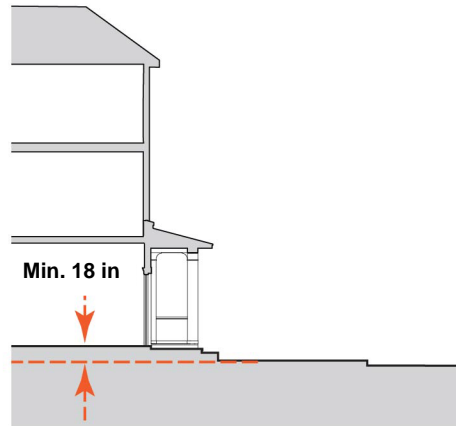

5. **Window and Door Design.**

- a. *Window Shape.* Primary windows may be square, vertically-oriented and rectangular, or vertically-oriented and arched. Secondary windows must be smaller in size than primary windows and may be square, vertically-oriented and rectangular, or vertically-oriented and arched.
- b. *Window Recess and Trim.* All windows must:
  - i. Include trim at least 2 inches in width (foam or vinyl trim not permitted); or
  - ii. Be recessed a minimum of 2 inches from the outer wall surface.
- c. *Windows Material.* Vinyl is not a permitted window material.
- d. *Divided Lites.* Simulated divided-lite grilles are acceptable only if they are located on both the outside and inside faces of the window, have spacer bars between the double panes of glass, and a thickness of at least 1/2 inch on each side of the window. 50 percent of windows must have a divided lite design.
- e. *“360-Degree” Design.* All primary windows on each floor of each façade must be the same design, proportions, trim, material, and color.
- f. *Glazing.* All glazing types are permitted except reflective or opaque tinting of glazing, which are prohibited.
- g. *Residential Signifiers.* Residential facades shall incorporate at least one of the following elements that signal habitation: window bays, usable balconies, or horizontal cornices or string courses at every floor.

6. **Residential Unit Design.**

- a. *Affordable Unit Design.* Affordable units and market-rate units in the same development shall be constructed with the same exterior materials so that the units are not distinguishable.
- b. *Private Open Space.*
  - i. Minimum 100 square feet per unit.
  - ii. Private open space may be at-grade or elevated.
- c. *Common Open Space.*

- i. Minimum 500 square feet per lot or 25 square feet per unit, whichever is greater.
- ii. Minimum dimension 15 feet.
- iii. Shared open space may be at-grade, elevated, or rooftop.
- iv. Where required common open space abuts private open space, an access drive, or the public right-of-way, then a minimum 2-foot-wide buffer is required. The buffer must be planted or otherwise designed to be screened from view from the private open space.

**7. Parking and Driveway Design.**

- a. *Parking Design.* Parking must be located in:
  - i. Tuck-under individually secured garages on the ground level of a structure in Zone C; or
  - ii. Shared garage (podium or underground) in Zone C or D.
- b. *Driveway Width.* Driveways may not exceed 20 feet in width.
- c. *Parking Visibility.* Street-facing structured parking levels are not permitted at the ground-level unless the parking level exterior matches that of the living area.
- d. *Garage Doors.*
  - i. All garage doors must be motorized.
  - ii. Controlled entrances to shared parking facilities (gates, doors, etc.) shall be located a minimum 10 feet from the back of sidewalk and may not exceed 20 feet in width.
- e. *Long-term Bicycle Parking.*
  - i. A minimum of one long-term bicycle parking space shall be provided for every 4 residential units.
  - ii. Long-term bicycle parking must be located on the same lot as the use it serves and:
    - (a) In a parking facility;
    - (b) In an enclosed bicycle locker; or
    - (c) In a fenced, covered, and locked bicycle storage area.
- f. *Bicycle and Auto Parking Clearance.* 5 feet of vertical clearance shall be provided between vehicle and bicycle parking spaces. 2 feet of vertical clearance shall be provided between bicycle parking spaces and adjacent walls, poles, landscaping, street furniture, drive aisles, and pedestrian walkways.

**8. Equipment Screening.**

- a. *Solar Equipment.* Rooftop solar panels shall have a low-profile, flush-mounted design, with a maximum of 6-inch gap between the solar panel and the roof material unless the roof is flat. If solar panels are mounted on a flat roof and are tilted or angled to maximize solar energy production, building parapets or other architectural elements shall provide screening from view from the public right-of-way and from adjacent single-family uses within 300 feet. Screening shall be architecturally continuous with the building in color, material, and trim cap detail.
- b. *Height of Roof-mounted Equipment.* Roof mounted equipment greater than 12 inches above the roof line, except for roof exhaust vents, plumbing vents, and solar panels on pitched roofs, shall be screened from being viewed from the public right-of-way and from adjacent single-family uses within 300 feet.

- c. *Location of Ground-mounted Equipment.* Neither mechanical nor electrical equipment is allowed in street-facing setbacks or interior side setbacks facing and abutting single-family uses on lots in Zone A.
  - d. *Visibility of Ground-mounted Equipment.* Site-and ground-mounted mechanical or electrical equipment shall be screened using plant materials, fencing, or walls from public right-of-way. Conduits shall not be exposed on exterior walls and shall be embedded in walls or within a chase designed for such use.
  - e. *Screening Height.* All screen devices shall be as high as the highest point of the equipment being screened.
  - f. *Drain-Waste-Vent System.* Supply, exhaust and venting plumbing, conduits, and flues shall be concealed within the walls of a building.
9. **Additions and Remodels.** In order to ensure that proposed additions and remodels match the existing building, any remodels and additions must incorporate only the architectural design elements, proportions, materials, and details that are already on the existing building.

### C. Façade Design.

#### 1. Blank Walls.

- a. *Limit on Blank Walls.* Blank walls on any floor may not exceed 12 horizontal feet.
- b. *Enhancement on Blank Walls.* Blank walls at the ground level must include one or more of the following:
  - i. A pattern of motifs or insets in tile or stucco;
  - ii. A base or water table at least 2.5 feet in height and a cornice at the top of the ground level;
  - iii. Landscaping that, at maturity, obscures a minimum 50 percent of the wall area, and that is guaranteed for a period of 10 years, minimum; or
  - iv. Landscaped trellises or lattices over a minimum 50 percent of the wall area that is guaranteed for a period of 10 years, minimum.

#### 2. Building Materials, Colors, and Finish.

- a. *Primary Building Materials.* A primary building material shall mean a material that covers 60 percent or more of a façade surface area excluding transparent surfaces. When there is a change in exterior building material, the material change must occur at the inside corner of a building form, or a minimum of 8 feet beyond an outside corner. The following primary cladding materials are allowed:
  - i. Stucco (minimum 2-coat)
  - ii. Stone (must extend vertically to the foundation)
  - iii. Stone-colored brick (must extend vertically to the foundation)
  - iv. Exterior insulation finishing system (EIFS) panels
- b. *Secondary Building Materials.* A secondary building material shall mean a material that covers less than 40 percent of a façade surface area excluding transparent surfaces. The following secondary cladding materials are allowed:
  - i. Metal (wrought iron, copper, bronze) with a non-reflective finish
  - ii. Wood
  - iii. Split-face Concrete Masonry Unit (CMU)

- iv. Terra cotta tile
- v. Brick or brick veneer
- vi. Glazed tile
- c. *Building Colors.* A maximum of four colors shall be applied to be the building façade:
  - i. Primary color comprising 60 percent or more of the façade.
  - ii. Secondary color comprising no more than 30 percent of the façade.
  - iii. Tertiary color comprising no more than 10 percent of the façade.
  - iv. Accent color for use on trim and architectural details.

Materials with naturally occurring colors such as wood or stone, materials with prefinished color such as stucco, and colored metal shall constitute a color for this requirement.

- d. *Porches, Balconies, Decks, and Exterior Stairs.* Porches, balconies, decks, and exterior stairs must be stucco or wood. Railings must be stucco, wood or metal.
- e. *Timber Protection.* Exterior timber shall be protected from decay by stain and sealant.
- f. *Ferrous Material Protection.* Exterior ferrous metals shall be protected from corrosion either through the use of galvanized, stainless, or weathering steel.
- g. *Roof Materials.* Roof materials must be:
  - i. Composition shingle (Timberline Lifetime Architectural), brown or brown-red in color;
  - ii. Spanish barrel tile, regularly or irregularly laid, and brown or brown-red in color;
  - iii. Standing seam metal in a nonreflective dark brown or dark bronze color;
  - iv. Concrete roof tiles; or
  - v. Cool roof membrane roofing, non-reflective and medium gray color.

### 3. **Architectural Details.**

- a. *Structural Elements.* Structural elements visible on the building exterior (e.g. rafters, purlins, posts, beams, balconies, brackets, trusses, columns, arches, etc.), even when ornamental, shall be placed to frame building apertures and bays.
- b. *Parapet Design.* Patterns of steps, angles, and/or curves must be symmetrical within each segment or establish symmetry across the building façade.
- c. *Gutters.* All gutters shall contain features to direct rainwater away from exterior walls including one or more of the following:
  - i. Projecting eaves (minimum 12-inch projection)
  - ii. Scuppers (minimum 12-inch projection if no downspouts are used)
  - iii. Gutters with downspouts
- d. *Street Address Number.* Street address numbers must be metalwork or tiled.
- e. *Ornamental Features.* Buildings must exhibit at least two of the following ornamental features over 15% or more of each facade:



- i. Patterned accent tiles applied consistently across all street-facing building facades
    - ii. A pattern of carved insets with grilles on all street-facing building facades
    - iii. A pattern of stucco motifs or tile motifs or vents on all street-facing building facades
    - iv. Terra-cotta tile chimney top (enclosing equipment or not)
  - f. *Exceptions.* All building façades must comply with applicable standards with the following exceptions:
    - i. Materials used for the building base or podium need not be repeated.
    - ii. Where a building is designed to appear as separate buildings, each portion that appears as a separate building shall be subject to the Building Design and Façade Design standards separately.
4. **Additions and Remodels.** Notwithstanding the design standards of this Chapter, new or replacement windows or doors in an existing wall must have the same design, detail, and placement of existing windows or doors on the building.

#### D. **Site Design.**

##### 1. **Walls and Fences.**

- a. *Fences and Walls.* Fences and walls shall be the same materials and color with that of the primary or secondary building materials.
- b. *Retaining Walls.* The design of new retaining walls that are visible from the abutting public right-of-way, as well as those that are within the side and rear yard areas, shall be constructed in a stepped or terraced fashion with the maximum height for any single wall no more than 4 feet unless an engineering assessment finds that physical limitations do not make such terracing feasible. If the change in grade is greater than 4 feet, a series of retaining walls, interspersed by planting areas in a stepped or terraced fashion shall be constructed to minimize the retaining walls visual prominence and avoid a monolithic appearance. A minimum 6 foot masonry wall must be provided on property lines shared with single-family uses on lots in Zone A.
- c. *Retaining Wall Design.*
  - i. Retaining walls shall provide visual interest through the use of form, texture, detailing and planting. When a retaining wall contains an entry stairway to the residence, the design of the wall shall include the following features that emphasize the entryway: plantings or design features that match those of the primary building.
  - ii. Retaining wall material shall be concrete or CMU covered with plaster stucco a minimum of 2 inches thick.
- d. *Screening of Retaining Walls.* Where a single large retaining wall is used, its design shall incorporate a planting strip and irrigation system at its toe strip to allow for the planting of screening vegetation and/or a planting strip with irrigation system at the top of the wall. Planting strip must be a minimum 12 inches wide.
- e. *Gates.* Residential security gates, when installed, shall be the same color as the secondary building materials and be no more than 50 percent opaque.

##### 2. **Landscaping.**

- a. *Landscape Design.*

- i. Landscape species must be native, low-water usage, and low maintenance, meeting Water Efficient Landscape Ordinance requirements.
  - ii. Landscaping shall be placed according to sunlight needs.
  - iii. Landscaping shall be located to cover the entire development site and provide shade in south-facing and west-facing areas.
  - iv. Plant size at maturity must not exceed:
    - (a) 30 inches within 10 feet of a sidewalk or driveway
    - (b) The height of any building aperture within 10 feet of the aperture.
  - v. Existing mature trees shall be preserved and incorporated as part of the overall landscape design.
- b. *Required Landscaping.*
- i. Ground cover must be planted a maximum of 1 foot on center.
  - ii. The following does not count toward the required landscape area:
    - (a) Artificial turf; and
    - (b) Any area with a minimum dimension less than 30 inches.
- c. *Prohibited Species and Materials.* Plant species that are listed by California Invasive Plant Council (Cal-IPC) as invasive are prohibited, as is flammable mulch.
- d. *Frontage Landscaping.*
- i. The required street setback area must be landscaped except for areas of ingress and egress.
  - ii. Landscaping may include container plantings, groundcover, turf, climbing vines, shrubs, low hedges, and trees.
  - iii. A maximum of 20 percent of the required front setback area may be turf. Such turf area may not be counted toward the required landscaped area.
- e. *Interior Side and Rear Setback Landscaping.*
- i. Landscaping within side and rear setback areas shall be located to delineate property lines.
  - ii. All interior side and rear setbacks on lots which abut Zone A shall be planted with a mix of trees and shrubs. At least one tree of at least 15-gallon size shall be planted per 20 linear feet or as appropriate to create a tree canopy over the required setback. In addition, at least three shrubs shall be planted per 20 linear feet.
- f. *Grading.* To minimize impacts on existing terrain, the maximum amount of cut shall not exceed 5 feet below the natural grade and the amount of fill shall not exceed 3 feet above the natural grade.
- g. *On-site Drainage.* Drainage shall be provided on-site using natural drainage channels, bioretention areas, or other landscape areas that filter surface water runoff before it enters the storm drain system.
- h. *Backflow Preventer and Public Utilities.* Any backflow preventer or public utility, such as panels and meters, must be screened with landscaping as high as the equipment and landscaping must be guaranteed for a period of 10 years. Public utility connections must be installed in underground vaults and conduit.
3. **Site Circulation.**

- a. *Hardscape Materials.* On-site hardscape material shall be permeable or pervious and grey or light gray in color with a higher solar reflective index.
- b. *Paving within Setback Area.* Paving within required setback areas shall be distinct from the adjacent public sidewalk in color, design, or texture.
- c. *Curb Cut Frequency.* A maximum of one curb cut for driveway access may be permitted per street frontage per development project site.

4. **Refuse and Recycling Areas.**

- a. *Location.* Common refuse and recycling containers shall not be located:
  - i. Within any required street-facing setback;
  - ii. Any required parking and landscaped areas; or
  - iii. Any other area required to remain unencumbered, according to Fire and other applicable Building and Public Safety Codes.
- b. *Visibility.* Common refuse and recycling containers shall not be visible from the public right-of-way and shall be screened by landscaping. Fences or walls may be used if located outside a required setback.
- c. *Enclosure and Container Materials.*
  - i. Enclosure materials shall be the same as those of the primary building.
  - ii. Containers used for the collection and storage of refuse and recyclable materials shall meet the standards of the waste collection company and be:
    - (a) Constructed of a durable waterproof and rustproof material;
    - (b) Enclosed and covered when the site is not attended;
    - (c) Secured from unauthorized entry or removal of material; and
    - (d) Shall be sized to accommodate the volume of materials collected between collection schedules.
- d. *Clear Zone.* The area in front of and surrounding all enclosure types shall be kept clear of obstructions and accessible.
- e. *Drainage.* The floor of the enclosure shall have a drain that connects to the sanitary sewer system.

5. **Lighting.**

- a. *Entrance Lighting.* Light fixture(s) at all building entries are required.
- b. *Façade Lighting.* Lights on the building façade shall be incorporated into façade design for all facades. Fixtures shall be:
  - i. Fully shielded and directed downward onto the building façade and onto paving of entrance areas; and
  - ii. The same materials as the building trim/accent.
- c. *Low-level Lighting.* Low-level lighting shall be provided to ensure entry paths, entry stairs and driveways, garage and building entries are illuminated.

6. **Energy Efficiency.**

- a. All appliances must meet the applicable adopted Reach Codes.
- b. All appliances, HVAC and lighting shall be electric and energy-efficient.

## Commercial and Mixed-Use Design Standards

### A. Building Envelope Design.

1. **Upper-story Step-backs.** Along the interior side and rear façade facing and abutting single-family uses on lots in Zone A, the third and fourth story must be stepped back a minimum 5 feet from the ground floor façade.

Rear and Interior Side Façade when abutting Zone A

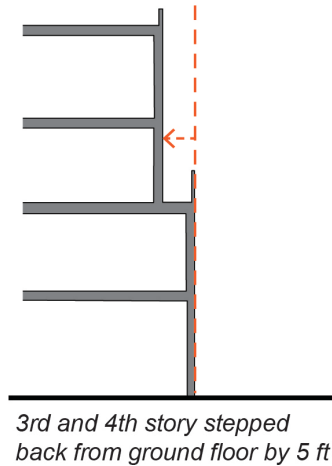

2. **Building Placement.**

- a. **Frontage.** A minimum 85 percent of ground-floor building frontage must be built at or within 18 inches of the front setback to create a continuous street wall.
- b. **Corner Lot.** At street corners, buildings must be placed at street yard setback line, and for a minimum 25 feet distance from, the intersecting street yard setback lines.

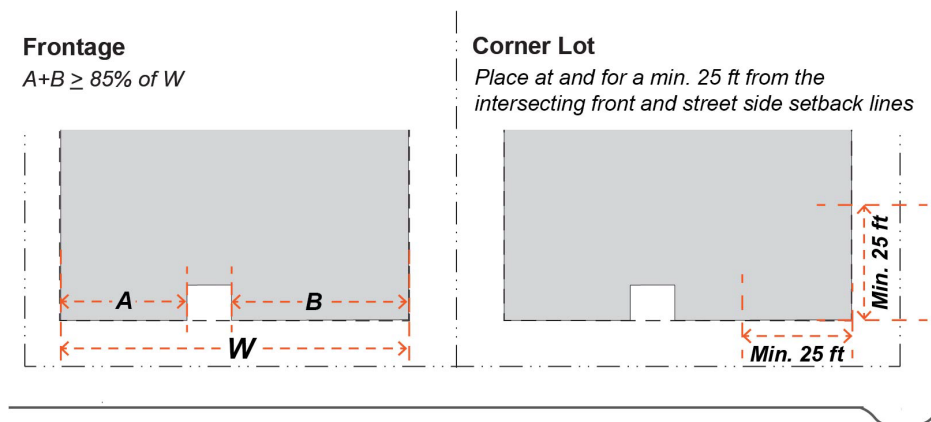

3. **Building Massing Abutting Zone A.** Building façade planes facing and abutting single-family uses on lots in Zone A may not exceed 40 feet in width without a break in massing minimum 6 feet in depth.
4. **Privacy.**
  - a. **Outdoor Habitable Space:** Balconies, decks and other habitable outdoor spaces facing and abutting single-family uses on lots in Zone A are not allowed on upper-story facades or roofs.

- b. **Balcony and Deck Placement.** Development shall place and orient balconies and decks accessed from the living room of each unit toward the street yards of a building.
- c. **Window Placement.** Windows to primary living spaces within 10 feet of and facing an interior side setback must be:
  - i. Be angled away from the adjacent side setback line a minimum of 30 degree, measured from a line perpendicular to the side setback line;
  - ii. Have a minimum sill height of 42 inches from the finished floor; or
  - iii. Use permanently translucent or “frosted” glazing.

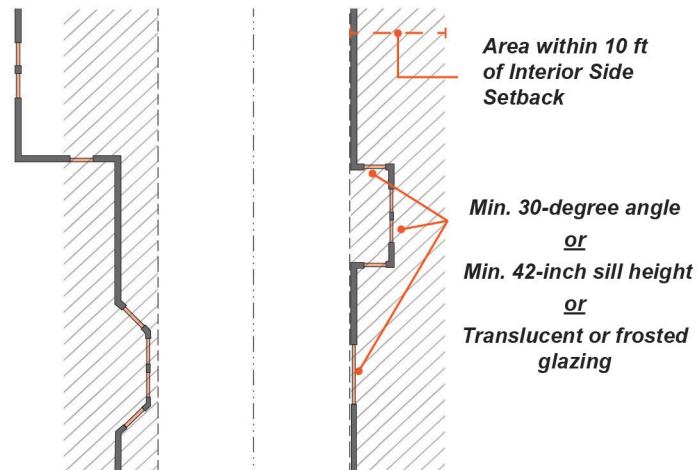

## B. Building Design.

### 1. Street-Facing Building Articulation and Façade Bays.

- a. **Vertical Articulation.**
  - i. Building facades up to 65 feet in length along a public right-of-way must incorporate at least one of the following:
    - (a) Window bays a minimum 3 feet in depth from building façade
    - (b) Recesses a minimum 3 feet in depth from building façade
    - (c) Porches or decks over a minimum 25 percent of the façade length.
  - ii. When a building façade exceeds 65 feet in length along a public right-of-way, it must be separated into façade bays no greater than 30 feet in width defined by a recess a minimum of 3 feet in depth and at least one of the following features:
    - (a) Change in roof parapet height or shape a minimum of 6 feet
    - (b) Change in roof form and type (e.g. gable roof to flat roof)

- (c) Change in building height, minimum 8-foot difference

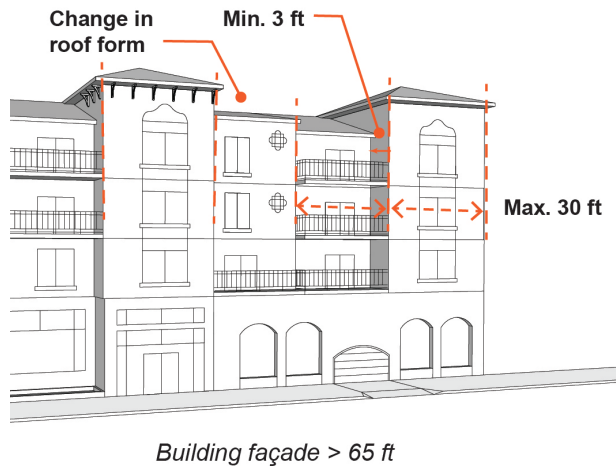

- b. **Bay Articulation.** The eave or roof form of a recessed façade bay shall be no higher than those of the façade bay located at the setback line.
- c. **Corner Design.** Development must accentuate building massing at roadway intersections with one of the following elements:
- i. A tower element at least 80 square feet in area;
  - ii. A decorative parapet; or
  - iii. A rounded corner and plaza.

## 2. Roof Form and Design.

- a. **Allowed Roof Forms.** Roof forms shall be limited to:
- i. Hipped
  - ii. Gable
  - iii. Dormers, which may not exceed 8 feet in length
  - iv. Parapet. Parapets segments may not exceed 20 feet in length without interruption in height or form.
  - v. Roof decks that are enclosed on the sides and rear, either partially or completely, provided the deck and occupants are not visible from the public right-of-way or adjacent single-family uses within 300 feet.
  - vi. Dentilled cornice minimum 3 feet high and continuous at roof line on all building facades
- b. **Pitch.** The pitch of the roof must be 3:12 to 5:12 ratio. Flat roofs are also permitted.
- c. **Eaves.** Eaves shall exceed 18 inches in depth and exterior brackets or beams are required wherever building height exceeds 30 feet.
- d. **Form and Design.** Solar roofs and other Building Integrated Photovoltaic (BIPV) roof designs are exempt from these roof standards if needed to achieve a net zero energy consumption result on site.
- e. **Roof Decks.** Roof decks are limited to a maximum of 30 percent of the building footprint.

## 3. Building Entries

- a. **Ground Floor Entrances.**



- i. Entrances to non-residential ground floor uses must be located on the front of the building and must face a public right-of-way. Entrances are limited to a minimum 2 per facade facing and abutting the public right-of-way or 1 for every 20 housing units per facade facing the public right-of-way, whichever is greater, in Zone D.
  - ii. Any shared or individual entrance to residential unit must be a minimum 8 horizontal feet from any entrances to non-residential uses.
  - iii. Shared entrances to residential units must have a roofed projection or recess with a minimum depth of 4 feet and a minimum horizontal area of 40 square feet.
- b. **Upper Floor Entrances.** Exterior stairs to upper floor units above the second floor are not permitted.
- c. **Frontage Types.** Building frontages must take one of the following forms:
- i. Shopfront frontage with dimensions as indicated below:
    - (a) Shopfront covered projection depth: Minimum 4 feet
    - (b) Shopfront covered projection distance from curb: Minimum 2 feet
    - (c) Shopfront covered projection height: Minimum 8 feet, maximum 10 feet
    - (d) Shopfront finish floor level above sidewalk: Minimum 6 inches, maximum 30 inches
    - (e) Shopfront bay width: Minimum 6 feet, maximum 20 feet

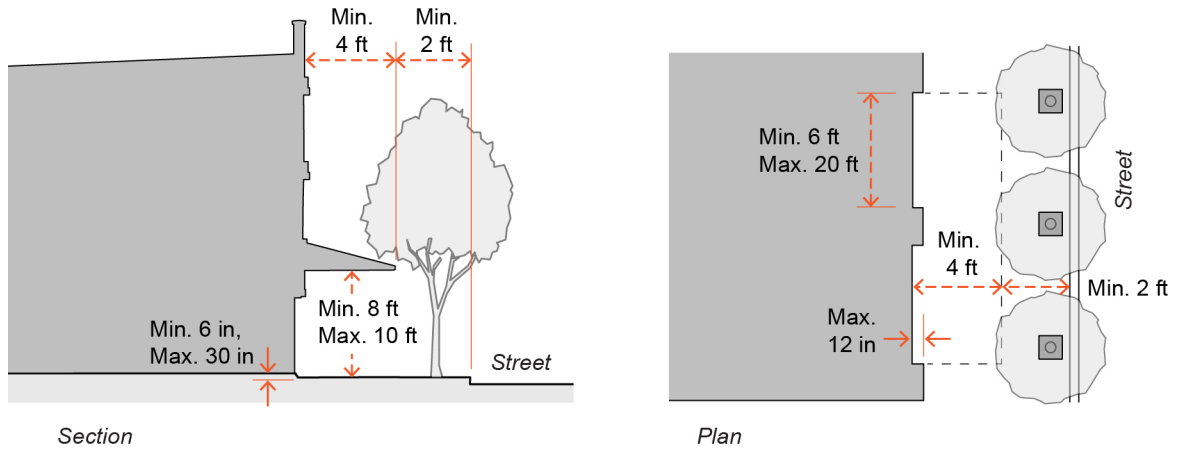

- ii. Terrace frontage with dimensions as indicated below:
  - (a) Terrace depth: Minimum 8 feet
  - (b) Terrace width: Maximum 120 feet
  - (c) Distance of terrace between stairs: Maximum 50 feet
  - (d) Terrace level above sidewalk: Minimum 18 inches, maximum 5 feet

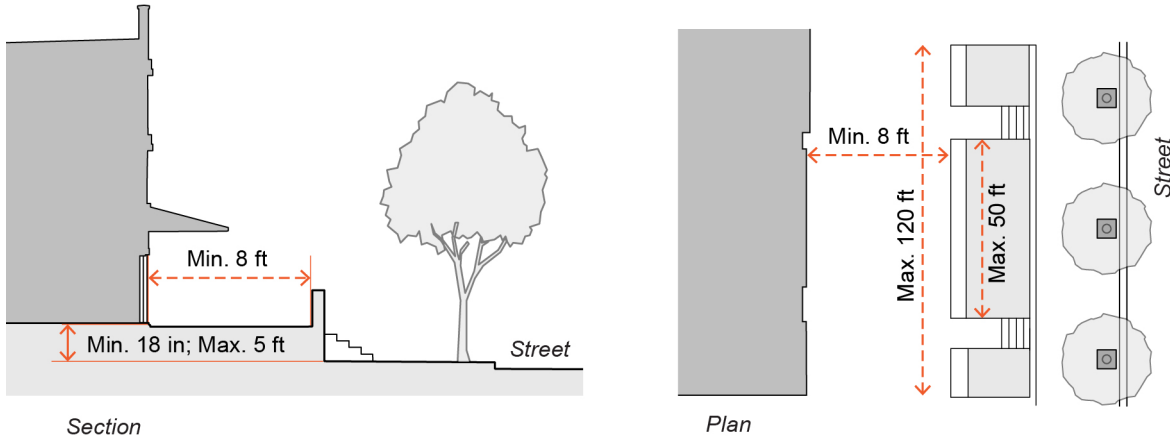

- iii. Covered arcade frontage with dimensions as indicated below:
  - (a) Arcade clear height: Minimum 12 feet, maximum 16 feet
  - (b) Arcade clear depth: Minimum 8 feet, must be consistent for the length of the arcade.
  - (c) Arcade column spacing: Minimum 4 feet clear between columns and maximum 12 feet between columns or as aligned with building bay architectural elements above.
  - (d) Arcade column height: Minimum 4 times column width, maximum 6 times column width
  - (e) Finish floor level above arcade floor: Maximum 6 inches
  - (f) Arcade distance from curb (encroachment permit may be required): Minimum 2 feet, maximum 6 feet

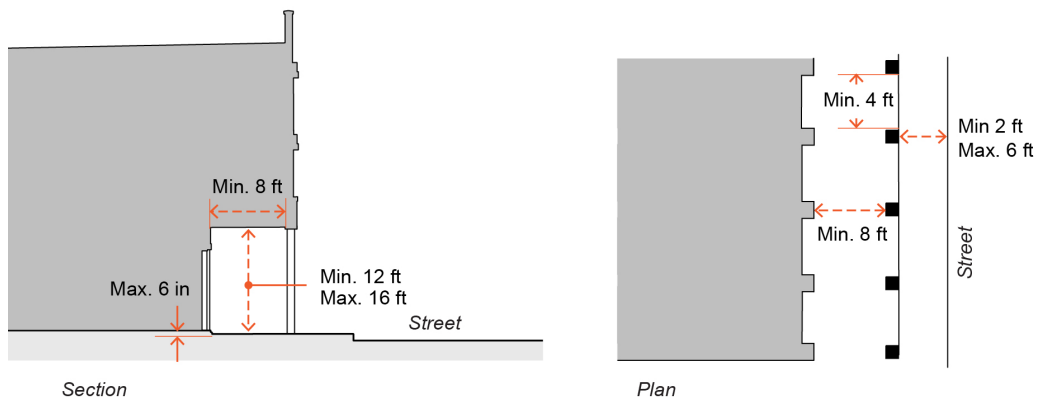

- d. **Shopfront Design.** On buildings on lots with street frontages that exceed 50 feet, shopfront and terrace frontages must incorporate:
  - i. A building recess of a maximum depth of 4 feet and minimum width of 6 feet to provide additional window display space; and
  - ii. Variations in bulkhead, awnings, materials and/or color to visually articulate the shopfront into bays a maximum of 20 continuous feet wide.

- e. *ADA Accessibility.* All frontages must comply with ADA accessibility requirements.

4. **Ground Floor Design.**

- a. *Ceiling Height.* The ground floor ceiling height must be a minimum 12 feet in the Grand Avenue subarea and 15 feet in the Highland Avenue subarea and a minimum 12 inches taller than upper floor levels' floor-to-ceiling height.
- b. *Finish Floor Elevation.* The ground floor finish floor elevation may be a maximum 24 inches above sidewalk elevation.

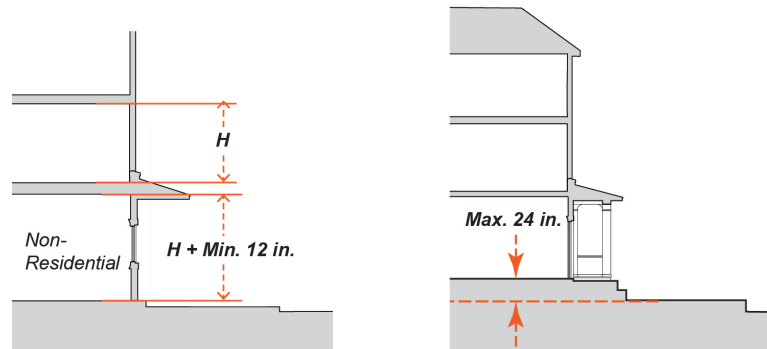

5. **Window and Door Design.**

- a. *Residential Window Shape.* Primary windows may be square, vertically-oriented and rectangular, or vertically-oriented and arched. Secondary windows must be smaller in size than primary windows and may be square, vertically-oriented and rectangular, or vertically-oriented and arched.
- b. *Window Recess and Trim.* All windows must:
- i. Include trim at least 2 inches in width (foam or vinyl trim not permitted); or
  - ii. Be recessed a minimum of 2 inches from the outer wall surface.
- c. *Windows Material.* Foam and vinyl are not permitted window materials.
- d. *Divided Lites.* Simulated divided-lite grilles are acceptable only if they are located on both the outside and inside faces of the window, have spacer bars between the double panes of glass, and a thickness of at least 1/2 inch on each side of the window. Residential primary windows must be a divided lite design.
- e. *Ground Floor Commercial Windows.* Ground floor windows must be horizontal or square in proportion rather than vertically oriented.
- f. *“360-Degree” Design.* All upper-story primary windows on each floor of each façade must have the same design, including proportions, trim, material, and color.
- g. *Glazing.* All glazing types are permitted except reflective or opaque tinting of glazing, which are prohibited.
- h. *Residential Signifiers.* Residential facades shall incorporate at least one of the following elements that signal habitation: window bays, usable balconies, or horizontal cornices or string courses at every floor.

6. **Residential Unit Design.**

- a. *Affordable Unit Design.* Affordable units and market-rate units in the same development shall be constructed of the same exterior materials and details such that the units are not distinguishable.

- b. *Private Open Space.* Minimum 100 square feet per unit. May be at-grade or elevated.
- c. *Common Open Space.*
  - i. Minimum 400 square feet per lot or 20 square feet per unit, whichever is greater
  - ii. No dimension (length, width, or diameter) may be less than 15 feet.
  - iii. May be at-grade, elevated or rooftop.
  - iv. Where required common open space abuts private open space, access drive, or public right-of-way a minimum 2-foot buffer is required. The buffer must be planted or otherwise designed to be screened from view from the private open space.

## 7. **Parking and Driveway Design.**

- a. *Parking Design.* Parking may be located in:
  - i. A shared garage (podium or underground)
  - ii. An above-ground parking structure enclosed with street-facing residential or retail uses. This configuration is known as a “wrap” or “lined” building.
- b. *Driveway Width.* Driveways to shared garages may not exceed 30 feet in width.
- c. *Parking Visibility.* Visible structured parking must be screened from view from the right-of-way by:
  - i. Regular punched openings designed to resemble windows of habitable spaces; or
  - ii. Trellis/living wall surfaces.
- d. *Parking Separation.* Parking for residential units shall be separated from parking for non-residential uses through a controlled fence, gate, or other barrier.
- e. *Garage Doors.*
  - i. All garage doors must be motorized.
  - ii. Controlled entrances to shared parking facilities (gates, doors, etc.) may not exceed 20 feet in width.
- f. *Short-term Bicycle Parking.*
  - i. Short-term bicycle parking must be provided at a rate of 10 percent of required vehicular spaces or housing units, whichever is greater.
  - ii. Short-term bicycle spaces must be a stationary, securely anchored bicycle rack to which a bicycle frame and one wheel (two points of contact) can be secured if both wheels are left on the bicycle. One such bicycle rack may serve multiple bicycle parking spaces.
- g. *Long-term Bicycle Parking.*
  - i. Required long-term bicycle parking shall be provided as follows:
    - (a) Residential Uses: A minimum of one bicycle parking space for every 4 residential units.
    - (b) Other Uses: 15 percent of required vehicular spaces.

- ii. Long-term bicycle parking must be located on the same lot as the use it serves in: a parking facility; an enclosed bicycle locker; a fenced, covered, and locked bicycle storage area; or another secure area approved by the Planning Director.
  - h. *Bicycle and Auto Parking Clearance.* 5 feet of vertical clearance shall be provided between vehicle and bicycle parking spaces. 2 feet of vertical clearance shall be provided between bicycle parking spaces and adjacent walls, poles, landscaping, street furniture, drive aisles, and pedestrian walkways.
- 8. **Equipment Screening.**
  - a. *Solar Equipment.* Rooftop solar panels shall have a low-profile, flush-mounted design, with a maximum of 6-inch gap between the solar panel and the roof material or on a flat roof. If solar panels are mounted on a flat roof and are tilted or angled to maximize solar energy production, building parapets or other architectural elements shall provide screening from view from the right-of-way and from adjacent single-family uses within 300 feet. Screening shall be architecturally continuous with the building in color, material, and trim cap detail.
  - b. *Height of Roof-mounted Equipment.* Roof mounted equipment greater than 12 inches above the roof line, except for roof exhaust vents, plumbing vents, and solar panels on pitched roofs, must be screened from being viewed from the public right-of-way and from adjacent single family uses within 300 feet.
  - c. *Location of Ground-mounted Equipment.* Mechanical and electrical equipment is not allowed in setbacks.
  - d. *Visibility of Ground-mounted Equipment.* Site-and ground-mounted mechanical or electrical equipment shall be screened using plant materials, fencing, or walls from public right-of-way. Conduits shall not be exposed on exterior walls and shall be embedded either in walls or in a chase designed for such use.
  - e. *Screening Height.* All screen devices shall be as high as the highest point of the equipment being screened.
  - f. *Drain-Waste-Vent-System.* Supply, exhaust and venting plumbing, conduits, and flues shall be concealed within the walls of a building.
- 9. **Additions and Remodels.** In order to ensure that proposed additions and remodels match the existing building, any remodels and additions must incorporate only architectural design elements, proportions, materials, and details that are already on the existing building.

## C. **Facade Design**

### 1. **Transparency and Blank Walls.**

- a. *Required Ground-Floor Transparency.*

- i. A minimum 50 percent of commercial ground floor street-facing facades between 2 and 7 feet in height shall be transparent window surface with unobstructed views to the interior commercial spaces.

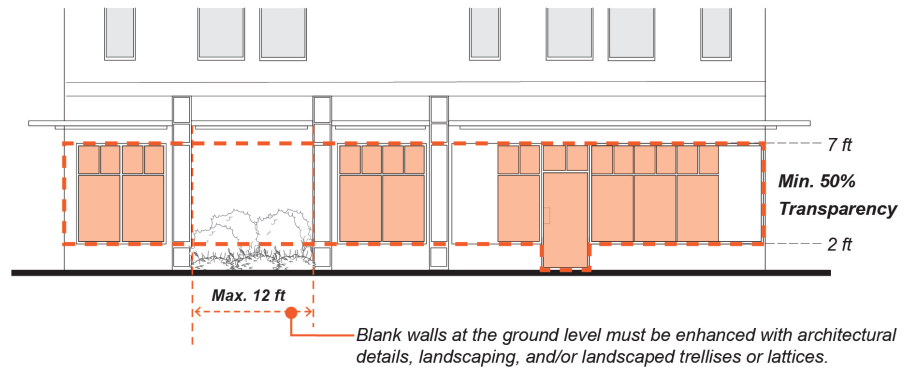

- ii. Ground floor leasable commercial space shall have a minimum interior floor-to-ceiling height of 14 feet.
- iii. Ground floor leasable commercial space shall have a minimum depth of 50 feet for at least 50 percent of the length of the building.
- iv. Opaque, reflective, or dark tinted glass is not allowed.
- b. *Limits on Blank Walls.* The maximum length of blank walls is 12 feet on any floor.
- c. *Enhancement on Blank Walls.* Blank walls at the ground level must include one or more of the following or 15% of all building facades:
- A pattern of insets, tiles, or stucco motifs;
  - A base or water table at least 2.5 feet in height and a cornice at the top of the ground level;
  - Landscaping that, at maturity, obscures a minimum 50 percent of the wall area, and that is guaranteed for a minimum of 10 years; or
  - Landscaped trellises or lattices over a minimum 50 percent of the wall area and that is guaranteed for a minimum of 10 years.

## 2. Building Materials, Colors, and Finish.

- a. *Primary Building Materials.* A primary building material shall mean a material that covers 60 percent or more of a façade surface area excluding transparent surfaces. The following primary cladding materials are allowed:
- Stucco (minimum 2-coat)
  - Stone (must extend vertically to the foundation)
  - Stone-colored brick, tan in color (must extend vertically to the foundation)
  - Exterior insulation and finish system (EIFS) panels
- b. *Secondary Building Materials.* A secondary building material shall mean a material that covers less than 40 percent of a façade surface area excluding transparent surfaces. The following secondary cladding materials are allowed:

- i. Metal (wrought iron, copper, or bronze) with a non-reflective finish
  - ii. Wood
  - iii. Split-face Concrete Masonry Unit (CMU)
  - iv. Terra cotta tile
  - v. Brick or brick veneer
  - vi. Glazed tile
- c. **Building Colors.** A maximum of 4 colors shall be applied to be the building façade:
- i. Primary color comprising 60 percent or more of the façade
  - ii. Secondary color comprising no more than 30 percent of the façade
  - iii. Tertiary color comprising no more than 10 percent of the façade
  - iv. Accent color for use on trim and architectural details.

Materials with naturally occurring colors such as wood or stone, materials with prefinished color such as stucco, and colorized metal shall constitute a color for this requirement.

- d. **Porches, Balconies, Decks, and Exterior Stairs.** Porches, balconies, decks, and exterior stairs must be stucco or wood. Railings must be stucco, wood or metal.
- e. **Change in Exterior Building Material.** When there is a change in exterior building material, the material change must occur at the inside corner of a building form, or a minimum of 8 feet beyond an outside corner.
- f. **Timber Protection.** Exterior timber shall be protected from decay by stain and sealant.
- g. **Ferrous Material Protection.** Exterior ferrous metals shall be protected from corrosion either through the use of galvanized, stainless, or weathering steel.
- h. **Roof Form and Materials.** Roof form shall be gable, hipped, or a flat roof. Flat roof must have a continuous parapet or cornice a minimum of 3 feet high. Roof materials must be:
  - i. Composition shingle (Timberline Lifetime Architectural), brown or brown-red in color;
  - ii. Spanish barrel tile, regularly or irregularly laid, and brown or brown-red in color;
  - iii. Standing seam metal in a non-reflective dark brown or dark bronze color;
  - iv. Concrete roof tiles;
  - v. Cool roof membrane roofing, in a non-reflective medium gray.

### 3. **Architectural Details.**

- a. **Structural Elements.** Structural elements visible on the building exterior (e.g. rafters, purlins, posts, beams, balconies, brackets, trusses, columns, arches, etc.), even when ornamental, shall be placed to frame building apertures and bays.
- b. **Parapet Design.** Parapets longer than 12 feet in length shall exhibit a combination of steps, angles, and/or curves. Patterns of steps and curves must be symmetrical within each segment or establish symmetry across the building façade. If parapets terminate with coping, the coping must be stone, concrete, tile, or molded stucco.

- c. **Gutters.** Features to direct rainwater away from exterior walls shall include one or more of the following:
    - i. Projecting eaves (minimum 12-inch projection)
    - ii. Scuppers (minimum 12-inch projection if no downspouts are used)
    - iii. Gutters with downspouts.
  - ci. **Street Address Number.** Street address numbers must be metalwork or tiled.
  - cii. **Ornamental Features.** Buildings must exhibit at least two of the following ornamental features over a minimum 15% of building facades:
    - i. Patterned accent tiles applied consistently across all street-facing building facades
    - ii. A pattern of carved insets with grilles on all street-facing building facades
    - iii. A pattern of stucco motifs or tile decorative vents on all street-facing building facades
    - iv. Terra-cotta tile chimney top (enclosing equipment or not)
  - ciii. **Exceptions.** All building façades must comply with applicable standards with the following exceptions:
    - i. Materials used for the building base or podium need not be repeated.
    - ii. Where a building is designed to appear as separate buildings, each portion that appears as a separate building shall be subject to the Building Design and Façade Design standards separately.
4. **Additions and Remodels.** Notwithstanding the design standards of this Chapter, new or replacement windows or doors in an existing wall must have the same design, detail, and placement of existing windows or doors on the building.

#### D. **Site Design.**

##### 1. **Walls and Fences.**

- a. **Fences and Walls.** Fences and walls shall have the same materials and color as that of the primary or secondary building materials.
- b. **Retaining Wall Height.** The design of new retaining walls that are visible from the abutting public right-of-way, as well as those that are within the side and rear yard areas, shall be constructed in a stepped or terraced fashion with the maximum height for any single wall no more than 4 feet, unless an engineering assessment finds that physical limitations do not make such terracing feasible. If the change in grade is greater than 4 feet, a series of retaining walls, interspersed by planting areas in a stepped or terraced fashion shall be constructed to minimize the retaining wall's visual prominence and avoid a monolithic appearance. A minimum 6 foot masonry wall must be provided on shared property lines with single-family uses on lots in Zone A.
- c. **Retaining Wall Design.**
  - i. In order to provide visual interest, retaining walls shall incorporate one or more of the following: use of form, texture, detailing, and/or planting. When a retaining wall contains an entry stairway to the building, the design of the wall shall include features that emphasize the entryway, such as plantings or design features that match those of the primary building.
  - ii. Retaining wall material shall be concrete or CMU covered with plaster stucco a minimum of 2 inches thick.



- d. *Screening of Retaining Walls.* Where a single large retaining wall is used, its design shall incorporate a minimum one foot deep planting strip and irrigation system at its toe strip for the length of the wall to allow for the planting of screening vegetation and/or a planting strip with irrigation system at the top of the wall. Landscape screening shall be guaranteed for a minimum of 10 years.
- e. *Gates.* Residential security gates, when installed, shall be the same color as the building materials and be no more than 50 percent opaque.

## 2. **Landscaping.**

- a. *Landscape Design.*
  - i. Landscape species must be native, low-water usage, and low maintenance, meeting Water Efficient Landscape Ordinance requirement.
  - ii. Existing mature trees shall be preserved and incorporated as part of the overall landscape design.
- b. *Required Landscaping.* Landscape plantings must cover all unbuilt areas of a lot.
  - i. Required landscaping coverage is 30 to 20 percent of the area of a lot in Zone C and 10 percent of a lot in Zone D.
  - ii. Ground cover must be planted a maximum of 1 foot on center.
  - iii. The following may not count toward the required landscape area:
    - (a) Artificial turf
    - (b) Any area with a minimum dimension less than 30 inches
- c. *Prohibited Species and Materials.* Plant species that are listed by California Invasive Plan Council (Cal-IPC) as invasive prohibited, as is flammable mulch.
- d. *Frontage Landscaping.*
  - i. *Civic Center Subarea:* Planter beds, window boxes, and/or container plantings are required at all façade insets, niches, and entries.
  - ii. *Grand Avenue Subarea:* The required street yard setback area must be landscaped except for seating areas, on-site plazas, and areas of ingress and egress. Landscaping may include container plantings, planter beds, groundcover, climbing vines, shrubs, low hedges, and trees.
- e. *Interior Side and Rear Setback Landscaping.*
  - i. Landscaping within side and rear setback areas shall delineate property lines.
  - ii. All interior side and rear yard setbacks abutting Zone A shall be planted with a mix of trees and shrubs. At least one tree of at least 15-gallon size shall be planted per 20 linear feet or as appropriate to create a tree canopy over the required setback. In addition, at least three shrubs shall be planted every 20 linear feet.
- f. *Grading.* To minimize impacts on existing terrain, the maximum amount of cut shall not exceed 5 feet below the natural grade and the amount of fill shall not exceed 3 feet above the natural grade.
- g. *On-site Drainage.* Drainage shall be provided on-site using natural drainage channels, bioretention areas, or other landscape areas that filter surface water runoff before it enters the storm drain system.
- h. *Backflow Preventer and Public Utilities.* See design standards for Multi-family development.

## 3. **Site Circulation.**

- a. *Hardscape Materials.* On-site hardscape material shall be permeable or pervious and grey or light grey in color with a higher solar reflective index.
  - b. *Paving Within Setback Area.* Plazas or outdoor seating areas located within street-facing setbacks must be separated from the sidewalk by landscaping or raised planters. Paving within required setback areas shall be different from the adjacent public sidewalk and consist of individual paving blocks.
  - c. *Curb Cut Frequency.* A maximum of one curb cut for driveway access may be permitted per street frontage per lot.
4. **Refuse and Recycling Areas.**
- a. *Location.* Common refuse and recycling containers shall not be located:
    - i. Within any required street-facing setback;
    - ii. Any required parking and landscaped areas; or
    - iii. Any other area required to remain unencumbered, according to Fire and other applicable Building and Public Safety Codes.
  - b. *Visibility.* Common refuse and recycling containers shall not be visible from the public right-of-way or from adjacent residential uses and shall be screened by landscaping. Fences or walls may be used if located outside a required setback.
  - c. *Enclosure and Container Materials.*
    - i. Enclosure materials shall be the same as those of the primary building.
    - ii. Containers used for the collection and storage of refuse and recyclable materials shall meet the standards of the waste collection company and be:
      - (a) Constructed of a durable waterproof and rustproof material;
      - (b) Enclosed and covered when the site is not attended;
      - (c) Secured from unauthorized entry or removal of material; and
      - (d) Shall be sized to accommodate the volume of materials collected between collection schedules.
  - d. *Clear Zone.* The area in front of and surrounding all enclosure types shall be kept clear of obstructions and accessible.
  - e. *Drainage.* The floor of the enclosure shall have a drain that connects to the sanitary sewer system.
5. **Lighting.**
- a. *Entrance Lighting.* Light fixture(s) at all building entries required.
  - b. *Façade Lighting.* Lighting on facades shall be incorporated into façade design for all facades. Fixtures shall:
    - i. Be shielded and directed downward onto the building facade and onto entry paving.
    - ii. Exhibit the same architectural style, design, and character as the primary building.
  - c. *Low-level Lighting.* Low-level lighting shall be provided to ensure entry paths, entry stairs and driveways, garage and building entries are illuminated.
6. **Energy Efficiency.**

- a. All appliances must meet the applicable adopted Reach Codes.
  - b. All appliances, HVAC and lighting shall be electric and energy-efficient.
7. **Parking Reductions.** One of the following parking reductions may be taken per development proposal:
- a. *Shared Parking Reductions.* Where a parking facility serves more than one non-residential use, the required parking spaces for both the residential and non-residential uses may be reduced up to 40 percent if:
    - i. The peak hours of use do not overlap or coincide by more than 2 hours;  
or
    - ii. A parking demand study prepared by an independent traffic engineering professional, approved by the City, finds that a proposed reduction will meet the development's projected parking demand.
  - b. *Transportation Demand Management (TDM) Parking Reductions.* The required parking for non-residential uses that incorporate one or more of the following Transportation Demand Measures may be reduced by 40 percent:
    - i. A minimum of three designated car-share, vanpool, or carpool parking spaces;
    - ii. On-site showers and lockers; or
    - iii. Transit subsidies or reimbursement offered to all to residents and employees.

## 3 Terms

**Arched Window.** Window that is rounded at the top.

**Blank Wall.** A portion of a façade on any floor of a building that does not include a transparent window or door between the level of the finished floor and the level of the ceiling.

**Common Open Space.** Courtyards, sport courts, play areas, gardens, landscaped plaza, or other open spaces for communal use within a development and accessible by all residents of the development.

**Dentilled Cornice.** A dentil, or small block, used as a repeating ornament under a cornice.

**Divided Lites.** A window with individual panes of glass separated by muntins, typically arranged in a grid. Simulated divided lite windows are made from a single, large pane of glass with a grid attached to both sides.

**Façade Bay.** A section of a building between vertical lines or planes, as defined by columns, pilasters, bay windows, or other horizontal projections or recesses, such as the space between two adjacent and vertical structural supports. Window bay is a type of façade bay that groups and organizes a series of windows in a vertical arrangement, aligned with other architectural features.

**Finished Floor.** The top layer of flooring.

**Forecourt.** A type of frontage with a portion of the façade set back from the primary façade creating a small landscaped courtyard space. The courtyard may be used as an entry court or as shared garden space for apartment buildings, or as an additional shopping or restaurant seating area within retail and service areas.

**Private Open Space.** A yard, patio, porch, or balcony directly accessible from the dwelling unit for which the open space provides an opportunity for private outdoor recreation and relaxation of the resident(s) of the associated dwelling unit.

**Rowhouse.** A single-family dwelling that shares a party wall with another of the same type placed side-by-side with individual entries along the front and dedicated private open space for each unit typically located in the rear. Each unit has its own front access at the ground floor. Also known as a townhouse or townhome. Each rowhouse facade is differentiated by a change in wall plane of at least 12 inches.

**Shared Garage.** A structured parking area that is shared by multiple residential units or commercial spaces.

**Shopfront.** A type of frontage, typically for commercial and retail use, where the façade is aligned close to the frontage line with the building entrance at the level of the sidewalk and which features windows to the interior of the commercial or retail use.

**Townhouse.** See Rowhouse.

*This page intentionally left blank.*

The following section has not been revised since the October 21, 2021 community workshop.

# 4 Test Site Massing Studies

## Zone D Civic Center Subarea Test Site

This hypothetical test site is located on a corner parcel in the Civic Center subarea of Zone D. The sample site is 150 feet wide and 132 feet deep, with frontage along Highland Avenue. This program for this project provides 15% affordable units and would be eligible for a concession for building height above 40 feet.

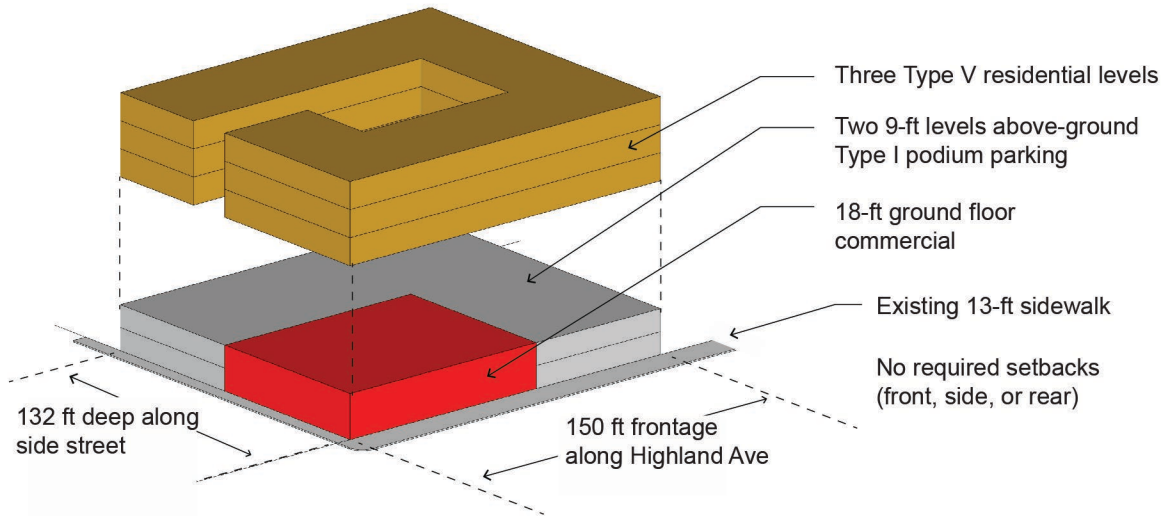

“Exploded” axonometric

Zone D Civic Center Subarea Test Site		
Site area	19,800 sq ft; 0.45 acres	
Residential levels	3	<i>Assumes height concession</i>
Total residential floor area	45,780 sq ft	<i>Each level approx. 15,260 gross sq ft</i>
Units (15% affordable)	37	<i>Assumes 1,250 gross sq ft per unit</i>
Density	81 du/ac	
Commercial area	6,476 sq ft	<i>Accommodates two small/medium spaces (e.g., a café and a clothing boutique)</i>
Total Floor Area	52,250 sq ft	
Total FAR	2.6	
Podium parking levels	2	<i>Both levels above-ground</i>
Total parking area	26,600	<i>Each level 13,300 gross sq ft</i>
Total spaces	66	<i>Assumes 400 gross sq ft per space</i>
Commercial parking spaces	12	<i>Approx. 2 per 1,000 sq ft</i>
Residential parking spaces	54	<i>1.5 spaces per unit</i>

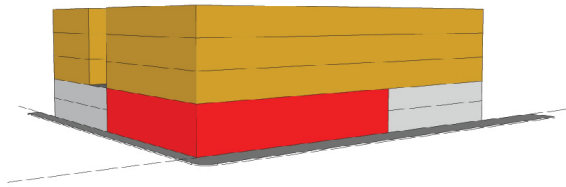

*Perspective massing diagram*

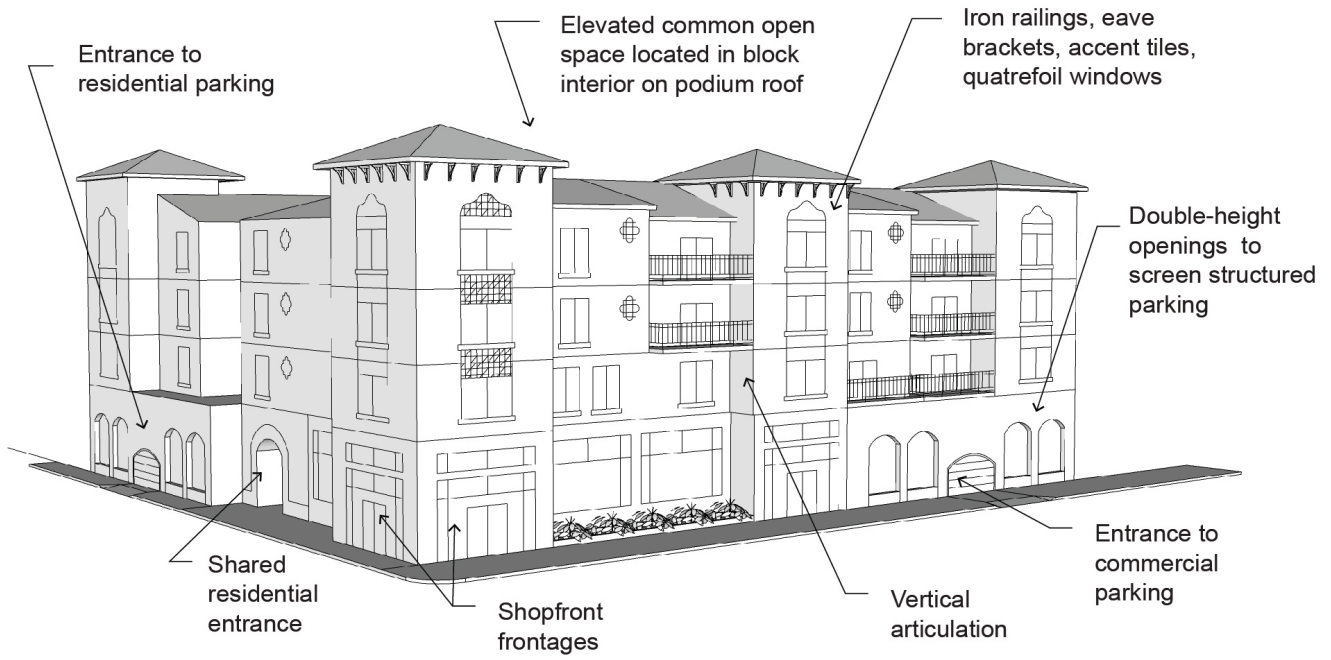

*Partial illustrative design concept*

## Zone D Grand Avenue Subarea Test Site

This hypothetical test site is located on a mid-block parcel on Grand Avenue in the Grand Avenue subarea of Zone D. The site is approximately 275 feet wide and 125 feet deep. This study assumes the project provides 15% affordable units and is therefore eligible for a concession to allow building height above 35 feet.

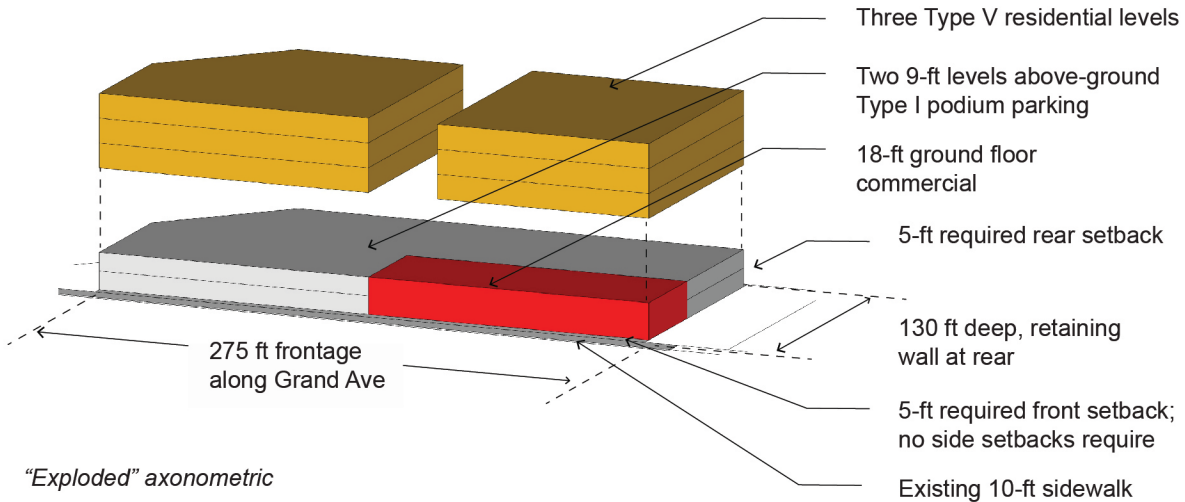

Zone D Civic Center Subarea Test Site		
Site area	34,630 sq ft; 0.79 acres	
Residential levels	3	<i>Assumes height concession</i>
Total residential floor area	82,800 sq ft	<i>Each level approx. 27,600 gross sq ft</i>
Units (15% affordable)	66	<i>Assumes 1,250 gross sq ft per unit</i>
Density	83 du/ac	
Commercial area	6,820 sq ft	<i>Accommodates two small/medium spaces (e.g., a small office and a hardware store)</i>
Total Floor Area	89,620 sq ft	
Total FAR	2.6	
Podium parking levels	2	<i>Assumed to be above-ground</i>
Total parking area	49,800 sq ft	<i>Each level 24,400 gross sq ft</i>
Total spaces	125	<i>Assumes 400 gross sq ft per space</i>
Commercial parking spaces	14	<i>Approx. 2 per 1,000 sq</i>
Residential parking spaces	111	<i>1.7 spaces per unit</i>



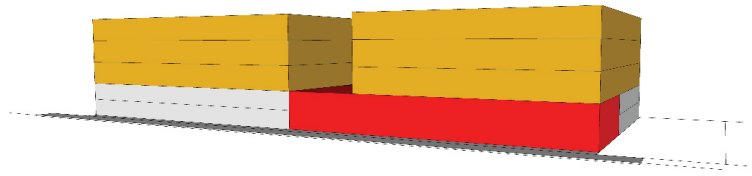

*Perspective massing diagram*

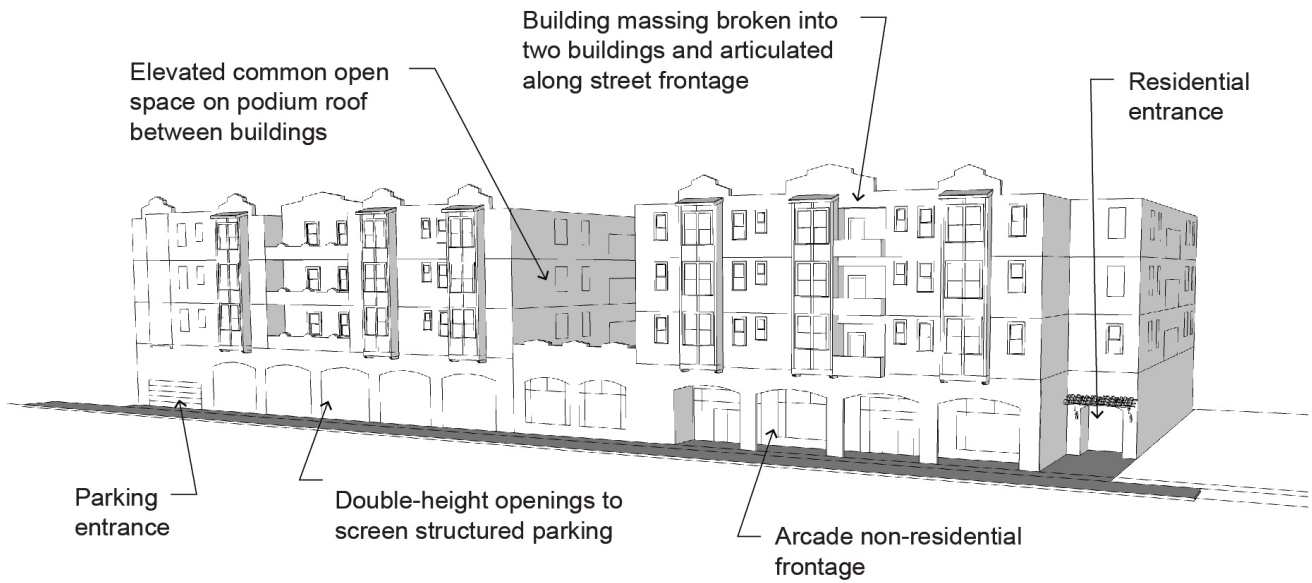

*Partial illustrative design concept*

## Test Site Feasibility

Below is a summary of the economic feasibility of the two test massing studies under the following three scenarios:

- 1) A base case scenario where development and design standards permit the building envelope shown above.
- 2) A density bonus scenario that includes affordable units in exchange for additional density and relaxation of height restrictions; and
- 3) A project that includes a 50 percent affordable housing that would allow for the project to qualify for permit streamlining under SB 35, and includes additional density.

A static development pro forma was created to test the potential return on investment of each of the three scenarios at the two Zone D test sites (the Civic Center Subarea site and Grand Avenue Subarea site).

### Key Assumptions

---

A set of common assumptions were used across the analysis for all three scenarios on both sites. Key assumptions, sourced from RS Means, include:

#### **Project Development**

- *Land costs:* \$240 per sq. ft.
- *Hard construction costs, residential:* \$195 per sq. ft
- *Hard construction costs, retail:* \$210 per sq. ft.
- *Parking costs:* Assumes podium and excavated spaces at \$45,000 per space
- *Soft costs:* 12% of total project costs
- *Financing costs:* Assumes construction and permanent loan financing

#### **Project Income**

- *Residential rents market rate:* \$2.47 per sq. ft. for 2-bedroom units
- *Residential rents affordable units:* Based on Alameda County Area Median Income (AMI) limits. Low income capped at \$2,512
- *Retail rents:* \$2.40 per sq. ft.

#### **Feasibility**

Three measures of feasibility were used to determine if the projects would be able to attract private investment given the development costs and anticipated net operating income (NOI) forecasted for each of the three scenarios.

- *Developer Profit:* This measures the capitalized value (cap rate) of the NOI minus the total project *development cost*. The residual is the developer's profit at a notional sale. This profit is expressed as a percentage of total project costs. A hurdle rate of 12.5 percent is used as an indicator of feasibility. This method is used as an indicator of the potential profitability for a private developer.

- *Return on Cost*: This measures the relative value of the NOI compared to the project's cost, relative to the cap rate. A return on cost that exceeds the cap rate by one percent is considered feasible. An alternative *measure* is the relative value of the investment which would have a hurdle rate of 8 percent. The return on cost is a measure of the relative "investment value" of the project.

## Key Findings

The projects developed under the three scenarios generated the following estimated returns:

**Table 1: Developer Profit**

	Civic Center Subarea Test Site	Grand Avenue Subarea Test Site	Feasible
<b>Base Scenario</b>	13.2%	13.9%	Yes
<b>Density Bonus Scenario</b>	17.5%	17.4%	Yes
<b>SB 35 Scenario</b>	5.0%	3.1%	No

**Table 2: Return on Cost**

	Civic Center Subarea Test Site	Grand Avenue Test Site	Feasible (Cap rate +1%)	Feasible (8% ROI)
<b>Base Scenario</b>	5.3%	5.3%	No	No
<b>Density Bonus Scenario</b>	5.5%	5.5%	Yes	No
<b>SB 35 Scenario</b>	4.8%	4.7%	No	No

These findings indicate that the Density Bonus scenario would be attractive to private investment and would be considered to be a feasible development opportunity. The Base scenario would also be attractive for a developer but would be of marginal interest for conventional financing. The SB 35 scenario would not produce attractive returns for a developer nor would it be able to attract financing.



**ODDS and ADU Incentives Comments and Edits****Compiled March 2022**

---

**Ms. Jane Lin:**

I have gone through the draft and made comments on the PDF. Please see below.

I hope that the LWC Team finds these suggestions helpful.

Generally the approach is good and the team has done some nice work.

-Jane

Page 5 – Does 70% frontage standard adequately allow for variation of projections and recesses and open space?

Page 6 – Part 3., top of page, how was a break of 6 feet arrived at? This is a very deep break recess or projection, the size of a balcony. Suggest allowing breaks with less dimension.

Part 4.c., i. – 30% orientation - this is a hard standard to interpret. What does it mean?

Part B.1.a.c. “porches of decks over a minimum 25 percent of the façade” How is this interpreted?

Part B.1.a.ii. change 25 façade bay to 30 feet façade bay which is typical of structural bay in multifamily development. Suggest that they match.

Page 7, top of page Roof line changes of 8 feet are a full story. Is that necessary? The illustration below shows roughly a change of 2 feet in height can provide the change, which is more typical.

Bay articulation standard seems unnecessarily prescriptive.

Page 8, top of page, omit roof-line balustrade which is not commonly found in Piedmont. Consider allowing roof decks that are completely private and partially or completely enclosed on sides. Is there a way where roof decks are permitted if concealed from ground floor visibility? There are many delightful roof decks that are still designed as private.

Part 3.a., why should buildings not have lobbies serving more than three units. Make the policy distinction clear. This is intended to encourage townhouse type building forms?

Page 9, Part d., Forecourt – consider allowing forecourt to be partially enclosed on three sides, meaning not the entire length of the forecourt.

Page 10, Part 6.d., Common Open Space - Consider adding privacy for adjacent units next to common spaces (with a buffer, perhaps). Increase minimum dimension to greater than 15 feet.

Page 12, Part C., Façade Design – why limit blank walls to 8 feet? What is the basis? Existing Piedmont design elements?

Part 2 EIFS is prohibited in many cities – why does Piedmont allow it? Used on the PUSD High School building. Cost-effective material.

I think stating primary color percentage is fine, but secondary and tertiary seems a little more excessive. Do applicants need to prove the facade coverage?

Page 13 – Parapet Design “...exhibit a combination of steps and/or curves”

Ornamental Features – these ODS standard should specify that security features like window or door bars should have their own standards.

Apply comments above to Zone D, Mixed-use Multifamily standards.

Page 24. For commercial spaces, require a minimum height or depth of the spaces. This is common for many other cities. Perhaps these would be in development standards. But, generally 16 feet minimum clear ground floor would be leasable retail space. Also, depth should be 50 feet minimum for at least 50% of depth.

---

**Mr. David Hobstetter:**

In reviewing the design standard documents I did not have any issues with it with the exception that perhaps I would like to see a little bit more flexibility in allowing good quality modern design in addition to the traditional approach.

---

**Mr. Houlands:**

Per your suggestion, here are my comments on ADU. Hope it helps

With considering neighborhood harmony and minimizing adjacent neighbor impact in mind, lift height limit from 16 to 18 even 20 feet, it not only improves the architectural appearance of an ADU, resulting improve overall existing community beautification, but also improves land use efficiency, reduce the challenges of lot coverage and provide nature living for those loving outdoor space, more home growing veggie option and improve overall healthy living of the community.

As you know a lot of homes in Piedmont were tiny vacation homes back century ago, lift size limitation from 800 sf to 1000 sf before all subject limitations kick in, which provide opportunities to improve living quality as entire community, provide a decent, possible living style people can dream about, reduce average square foot cost, and in resulting improving affordability.

Strongly recommend the City provide standard, good architectural design, pre-approved, ready to build plans to save work and cost for the city residents, most important is that to avoid overwhelmed city building and planning staffs to plan check and simplify inspections, like the city of San Jose, even Stockton, which provides free architecture and structure drawings and is ready to build with a city logo on the plans. That is the way to achieve a common goal for all citizens. With high city local taxes, residents deserve to have some incentives.

Lift some restrictions on size and income qualification, let people decide their lives. It is not a good idea to put too many political restrictions on people's lives. We are all good citizens and caring people, plus this is a free country, sorry, although I don't even know if we still are.

Thank you all for your reading and support.

---

**Mujahid Mahmood:**

I'm glad to see movement on loosening Piedmont's historically restrictive building rules. But ADU restrictions are still too burdensome - specifically, there is an existing restriction on front yard setback that limits ADU placement. This should be removed immediately. Design considerations could still be reviewed to ensure designs elements are in keeping with the neighborhood. We had presented an application for an ADU that built forward by 5-6 feet, had a wonderful design by a prominent Piedmont architecture firm, location chosen for it's specific use (flat entry for elderly parents) - but was denied because of this short sighted restriction. Please either remove this restriction or, at least, be willing to make exceptions to this restriction. Please let me know when the City is more open to this so we can resubmit our ADU plans.

I would recommend re-aligning to the minimal setback requirements per the ADU handbook (4ft, though currently it only places this limit on side/rear setbacks). Could keep design review to ensure overall design is in keeping with the neighborhood. At a minimum be open to approving ADU applications and making allowances for variances regarding front setback (this is currently not the case). I've been told by the City that there is no chance of our proposed plan being approved because of the front setback issue. We went through design review, etc. Very frustrating and costly process to only be denied a permit in the end.

from page 13 of the ADU handbook: "... setbacks must not unduly constrain the creation of ADUs..."

Sincerely, Mujahid Mahmood

---

**Elise Marie Collins:**

I am concerned that the Objective Design Standards are too restrictive. I wonder why there is no modern or modular designs to choose from.

In addition, I have concerns regarding the pre-approved ADU plans. I agree with all the recommendations of PREC experts especially those I have copied below.

I love ADUs, but we need to really study them to understand what part they play in our community. I am personally interested in ADUs that help households that wish to house multiple generations.

I encourage the city to consider developing pre-approved plans that enable modular or kit construction. This is a step many other cities have taken, including the City of San Jose.

I generally support the recommendations for creating incentives to owners to create deed-restricted limitations on rents. These ideas include allowing two-story ADUs or an additional ADU in exchange for deed restrictions.

At the same time, I believe we need accurate data on the effectiveness of ADUs as a path to affordable housing production in Piedmont in order to create more effective policies for the future.

Thank you for considering my input as well as the input of other community members.

Sincerely, Elise Marie Collins

---

**Anita Stapen:**

There is a huge amount of information to absorb in the new housing (programs). I would like to address one of these elements: the development and requirements for ADUs. Because I have no background in these areas, I will limit my comments to general concerns.

We all know that change is coming concerning the types and density of housing in Piedmont and indeed in California. Piedmont is taking a considered and active review process to meet the additional housing units, and I commend all the parties involved as we update the Building laws.

There is a lot of pressure to fulfill the state requirements, and I think the City is opening the door too wide to incentivize ADUs. The State does not allow a design review process for ADUs, but raising overall roof heights or increased area may have a big impact on neighbors' light, views, and privacy. As much as possible, I urge the City to prioritize concern for the impact on neighbors, who in these cases have no recourse if a tall or two-story ADU is built next door, compromising their privacy, light and view.

Related to this concern is the question of how many ADUs can be built in a given part of town? Will the City have a limit on ADUs per 10 block area, for example? Or some other measure? I haven't seen any data on how many ADUs have been built, or are being planned, or a mechanism to spread out the ADUs evenly over town.

Another issue is that many people would like to build ADUs not for additional housing stock, but to offer to friends and relatives who visit. How will this issue be addressed? Will the City require that new ADUs must be rented at low or very low market rates? What is the mechanism to regulate that?

In the pressure to create housing, Piedmont is overriding longstanding and very important aesthetic and privacy considerations that will negatively impact both the overall milieu, and impact neighbors. As we adapt to changes, I hope you keep these issues in mind and develop guidelines to minimize the impact of ADUs.

Sincerely, Anita Stapen

---

**Irene Cheng:**



I am writing to offer comment on Piedmont's draft Multi-Family Design Standards and ADU Incentives. The statements below represent my views as an individual, as an almost decade-long resident of Piedmont, and as a professional architectural historian and tenured professor of architecture.

The draft Multi-Family Design Standards are, in my view, conservative and overly restrictive. Many of the measures impose excessive costs on new multifamily development, placing burdensome obstacles in the way of new construction, and particularly new construction of affordable housing. They are also out of line with best practices in architectural design today, which operate under the guiding principle that each era should produce an architecture appropriate for its time rather than create faux-historicist built forms. The historicist perspective often equates ornament and variety with "good" or "appealing" design, but requirements for curved parapets, recesses, and brackets are no guarantee of beautiful architecture. In fact, they often lead to just the opposite.

By law, design standards must be objective not subjective. By this measure, there is no justification for "promoting development in a general Mediterranean architectural style" as the draft standards claim to do on page 3. Piedmont is fortunate to have architecture in a variety of styles, including Arts & Crafts, Mediterranean, Colonial Revival, modern, and contemporary. Why should the city elevate one style over another? Doing so suggests a conservative cultural and aesthetic attitude rather than an embrace of diversity and openness to change. Moreover, although the politics of architectural style is a complex and nuanced subject, recent research has explored the troubling racial politics underlying the popularization of Spanish Colonial Revival architecture (a variant of "Mediterranean") in early-20th-century southern California, a period of white Anglo migration and settlement. (See Phoebe Kropp's *California Vieja: Culture and Memory in a Modern American Place*, University of California Press, 2008.) This complex cultural history is just one more reason not to enshrine one style over any others. Instead, I hope the City will adopt objective design standards that concern themselves with universal concerns such as light, air, density, and privacy, while leaving aside subjective and culturally fraught questions of style and aesthetics.

I urge the City and its consultants to revise the proposed standards to ensure that new housing can feasibly be built, and that our city's architecture reflects an embrace of the present and future rather than remaining unduly tethered to a singular version of the past.

Yours truly, Irene Cheng, PhD, Architectural History, Columbia University, M.Arch, Columbia University

---

**Cynthia Kroll:**

Here are a couple of concerns I would like to see considered:

- 1) Will ADUs and JADUs add affordable housing to the city? How will this be ensured, to avoid them becoming simply Airbnb's or granny flats? How will building requirements take this into account (eg. high cost of new building vs manufactured units)?
- 2) What about parking? There are already neighborhoods grappling with parking congestion and overflows from nearby districts. Is the plan considering the parking needs generated by a) ADUs, b) changing a SF lot into a 2 plex or 4 plex, or c) building larger apartment buildings in our more commercial areas. It would be nice for the neighborhoods to know these things are being taken into consideration. That doesn't mean every ADU needs a garage, but what about ensuring the lot has

enough parking area in a driveway before allowing still more driving adults to be added? Will approaches to parking requirements depend on proximity to transit, so we don't assume just because Piedmont is seen as a transit accessible high opportunity area that transit is a realistic option in all parts of the city.

3) I would like to see as much new housing as possible added to the Grand Ave area and the Highland commercial area, so that we are not accommodating all of our RHNA through ADUs and JADUs.

Thanks, Cynthia Kroll

---

**Will Adams:**

Thank you all for the work you are doing on the housing mandate! The work done to date is impressive. Clearly the issue is complicated and interconnected to virtually all planning requirements, not the least of which, is preserving (and even improving) the beauty and charm of this place.

My comments center around two main concerns: cars and urban design.

1. Cars: Adding the required 575 (+-) units in Piedmont could, at 1.5 cars/unit, add ultimately 860 + cars to the city. I think any viable city expansion solution requires, for aesthetic, cost, congestion and parking reasons, a creative, innovative approach to reducing the number of and expenses associated with cars. This is part and parcel of 1a below.

1a. Parking: at \$45,000/structured parking space, \$68,000 (1.5 cars/unit) will be added to the average unit's building cost. Unfortunately this is the exact opposite of what is needed for affordable and low cost housing. I found the thinking in the following report a good outline of issues with a number of possible mitigations: <https://www.vtpi.org/park-hou.pdf> Also, there are some thoughts in Piedmont Post Sept 21, 2021, p. 21; Feb 10, 2021 p. 23. I wonder why the draft section on parking reduction only applies to non-residential use? Do you know if it has ever been a condition of lease or sale that vehicle ownership be limited? I would hope that with the state mandated huge, fast changes that are a part of getting new housing built, we could add new reasonable conditions that differ from current formulas.

2. Urban Design: because of its location and (assumed) availability, the Civic Center Subarea test site is certainly the most important development parcel in the Civic Center. Currently, it contains the essential Mulberrys and its parking lot, which, however lacking, function as the chief public outdoor space, certainly the most active, of the center. The building shown in the site massing study is nicely done, but I think the associated urban design needs development. Some sort of small replacement plaza should be incorporated into the plan (complementing/relating to the city hall plaza across Vista). Where do I sit to drink my coffee I just bought? Where is the student backpack pile located? Where do I park my bike? I also wonder if more of the parking could be buried behind even a minimum of additional commercial space at the sidewalk level. Although I think the addition of residential (and increased commercial) in this area will improve the center (and city) by adding activity and vitality, maybe this is not a good test parcel because of its unique prominence and required urban design/civic duty to the center of town. Whatever is done it needs to be an integral part of an overall urban design concept. See P.Post Dec 10, 2020 p.22. I understand that this is only a test and not a design proposal, but worry it could become one (a fixed design proposal).

2a. ADU's: the ADU work looks very impressive and appropriate. It's not clear to me though how exactly it works. The siting of the units can make all the difference. How is this regulated/determined without a design review process? Also I imagine there are a fair amount of ADU's possible within larger houses, maybe with small modifications—same question as above. There doesn't seem to be any mention of parking for ADUs in the draft, either for new units or vacated garage conversions....bringing us back to 1a above.

3. Building Costs: who knows, but the residential \$195/sf figure seems very low.

I hope these thoughts are in some way helpful.

---

**Garrett Keating:**

Below are my comments on the draft document, "Multi-family Design Standards and ADU Incentives".

Is difficult to assess the need for the ADU incentives in the draft without an analysis of the existing ADU program in Piedmont. That analysis would include the number ADUs that have been permitted, the number that are actually rented, the size of the added ADU and the number that are rented to low/very low-income tenants. Given all the analysis that went into other aspects of the report, it is surprising that so little has been done of existing and proposed ADU in Piedmont.

The impacts of ADU on neighborhoods is another analysis missing from the report. Piedmont has a long tradition of preserving the light, views and privacy of new development on neighboring properties but the report makes no acknowledgement of that. To the contrary, the report ignores these variables when proposing garage conversions, structures that are usually in close proximity to the property line.

“While noted as a potential affordable incentive in our report, relieving the height limit for an ADU constructed over an existing garage, assuming the footprint remains the same, would enable residents to maintain on-site covered parking while adding a dwelling unit to their property. This Carriage House model is a traditional way of providing an additional dwelling unit over a garage or storage building, and would seem consistent with much of Piedmont's existing residential fabric. Other California jurisdictions (Santa Monica and Orange County, for example) have adopted this option to encourage retaining existing parking counts. A similar limit on overall building height, and/or accommodation of roof pitch, as noted in the previous recommendation, would be appropriate.”

Suggesting that a residential unit within 4 feet of the property line is consistent with Piedmont's residential “fabric” demonstrates an ignorance of Piedmont's neighborhoods, particularly Zone A.

The only two controls that Piedmont has on ADU are building height and design compatibility and these controls should be preserved. Do not consider any increase in allowable ADU height at this time. Instead, incentivize ADU in other ways, most notably through increasing the allowed square footage of ADU and the raising of the FAR. The draft proposes modest increase in these two parameters but square footage and FAR should be expanded further before the city proposes height increases that impact neighbors. If at all, these incentives rightfully impact the ADU applicant and not the privacy and light of neighboring properties. Raising the height limit on ADU is an attempt to shoe-horn in units of

sub-optimal housing while horizontal expansion would create better housing. If a height incentive is to be considered, then limit it to 18 feet for rent-restricted units only.

Incentivizing ADU development to increase available housing in Piedmont is an accepted community goal. But so is preservation of the city's residential character and some of these ADU incentives are a real threat to that. Absent any analysis of the efficacy of the existing ADU program or a projection of how these incentives will help achieve the RHNA target, limit the current incentives to horizontal expansion only. With SB 9 and tax incentives, the city has other resources with which to incentivize additional and affordable housing.

Finally, one recommendation needs clarification. The report raises the possibility, not the requirement, of a 6 – 8 ft setback when a height limit of 20-22 feet is allowed and suggests this will mitigate impact on neighboring properties. That statement needs a lot more valid planning analysis.

Garrett Keating

---

**Mr. Randolph Wu:**

As Piedmont plans for multi-family and mixed-use project design in the next housing cycle, consideration should be given to integrating net zero energy housing designs into Piedmont's traditional building design standards. There is an important intersection between affordable multi-family housing and climate change. Higher density multi-family housing built near mass transit not only can be compliant with Reach Code standards but designed as net zero energy housing. This will be affordable and not reliant on the utility grid. Allowing architects, builders and homeowners to maximize renewable energy through nontraditional roof designs should be a high priority in Piedmont. Continuing improvements in solar panel efficiency and dramatic cost reductions in battery storage systems will make net zero energy housing feasible and cost effective for affordable multi-family housing projects in the next RHNA cycle.

There are two proposed standards (repeated in both the multi-family and mixed use building standards) that should be amended to enable cost effective, solar energy production:

*Building Design Standard B.2. Roof Form and Design*

An exception should be created for solar roofs or Building Integrated Photovoltaic (BIPV) roof designs. Net zero energy housing will require roof designs that will maximize solar energy production. This may not conform to traditional roof forms and designs in Piedmont, but it will help us reduce carbon emissions. This exception should be added as B.2.e as follows: "**Solar roofs and other Building Integrated Photovoltaic (BIPV) roof designs are exempt from these standards if needed to achieve a net zero energy result on site.**" It is important to tie this exception to net zero energy on site as otherwise the homeowner may use more energy than is produced on site and defeat the overall purpose to add housing with zero emissions.

*Building Design Standard B.8.a. Equipment Screening*

The second sentence which reads: "If solar panels are mounted on a flat roof and cannot be parallel to the roof surface, building parapets . . ." should be clarified. This sentence may be read to require a parallel mounting of solar panels on a flat roof unless it is physically impossible or "cannot" be done. This would be unfortunate as solar arrays in Piedmont should face south with a 38 degree tilt or angle to maximize annual solar energy production. A requirement for parallel or flat mounting will reduce energy production by as much as 10%. While this may not be intended, the standard should not suggest there is a requirement for parallel or flat mounting. This sentence should be amended to read: "If solar panels are mounted on a flat roof and **are tilted or angled to maximize solar energy production**, building parapets . . ." Tilted or angled solar arrays can be screened by a parapet from public ROW viewing. This seems to be the primary intent of B.8.a. (Please note that even a low parapet can create shade around the roof perimeter during the winter months and reduce the roof area that may be used for solar panels.)

Piedmont's building design standards should enable affordable multi-family housing and climate change initiatives.

Thank you for considering my comments.

Randy Wu

---

**Ms. Susan Miller Davis:**

Thanking Randy for weighing in and providing his expertise.

---

**Ms. Diana Edgerton:**

Can this affordable housing be restricted to Piedmont teachers and Piedmont City employees? A 2-bedroom apartment cannot accommodate a family. Currently, Piedmonters pay high taxes to support our own Police, Fire, other city services, etc. and, particularly, our excellent schools. How will these renters pay their fair share for these services?

---

**Ms. Mary Louise Morrison:**

I live on Moraga Ave. It already has buildings two deep.

Why not build in the land near the corporation yard, where the goats cleared the grass?

I just lost two oak trees - one 150 years old because of building over roots. Once you start housing in the old trees you are setting up either direct or indirect deforestation.

Street parking is impossible on Moraga and there really is no good public transit for Piedmont, especially for the elderly.

At this time in my life , I vote for the trees and high rises in the center of Piedmont so all Piedmont shares the consequences.

Mary Louise Morrison

---

**Mr. Alexander Czarnecki:**

I write to you today as the CEO of Cottage Technologies to encourage the Committee to implement a program for designer-owned preapproved ADU plans, in order to encourage the production of additional housing units in Piedmont through faster, cheaper, and more streamlined ADU creation.

As Piedmont looks to promote ADUs, a well-structured preapproval program provides several important incentives at once: 1) a less daunting experience for homeowners, 2) time savings, and 3) cost savings.

1. Streamlined process. Cottage supports a preapproved ADU program like those in San Jose and Cupertino, that allow designers and architects to submit non-site-specific ADU plans for preapproval and then work directly with homeowners throughout the course of their projects. We would also support a program that lets site-specific projects be concurrently processed for preapproval, similar to the program recently started in Fremont. Designer-owned preapproved plans, in contrast to city-owned preapproved plans, create a more streamlined experience for homeowners. In the latter type of program, homeowners must still seek out general contractors, consultants, and other professionals on their own, and challenges can occur when requests for information arise or the homeowner desires small modifications to the plans. In designer-owned plan programs, ADU experts are able to walk homeowners through the process from start to finish and assist homeowners through minor design changes, unforeseen site conditions, handoffs to contractors, and more.

2. Reduced turnaround time for permitting ADUs. In many municipalities, it can take over a year for a homeowner to receive a permit for and build an ADU, at a time when having additional rental income or a safe place to house elderly family members is more important than ever. And as rental prices rebound post-pandemic, an adequate supply of affordable rental units for local workers is critical to ensuring that cities and their economies can thrive upon reopening. An upfront guarantee of a fast permit process will help Piedmont more quickly meet the needs of its residents.

3. Reduced costs. Selecting a preapproved plan not only guarantees homeowners a faster permit turnaround time, but could also offer cost savings to both homeowners and Piedmont through less time spent in review. And when designers are able to offer homeowners an ADU cost estimate that includes both city fees and construction pricing for a preapproved plan, homeowners can rest easier knowing that their project will be within their budget and can pass some of these savings on to ADU occupants.

Fear of a cumbersome and costly permit process should not be a hindrance to homeowners looking to expand Piedmont's housing supply by building an ADU. An end-to-end, cost-effective preapproved ADU program would go a long way in broadening access to affordable housing opportunities for the elderly, local workers, and more. We're excited by Piedmont's engagement on this issue, and we look forward to

continuing to work with you and the community's homeowners.

Sincerely, Alexander Czarnecki, Founder & CEO, Cottage Technologies

---

**PREC Housing Committee:**

Attached please find feedback from the Piedmont Racial Equity Campaign Housing Committee on the draft Multifamily Design Standards and ADU Incentives.

Please contact us if you have any questions about our comments. Thank you!

Yours truly,

Irene Cheng  
[irene.cheng@gmail.com](mailto:irene.cheng@gmail.com)

Sarah Karlinsky  
[sarah.karlinsky@gmail.com](mailto:sarah.karlinsky@gmail.com)

On behalf of the PREC Housing Committee

--:/--

The members of the Piedmont Racial Equity Campaign Housing Committee have reviewed the draft "City of Piedmont Multifamily Design Standards and ADU Incentives." We appreciate the opportunity to review this important document. We have several specific comments, detailed below, but also an overall preliminary suggestion: Since the City is currently engaged in a thorough review of its Housing Element policies, and will probably revise its zoning regulations after that process is complete, we are concerned that many of these recommendations may soon be obsolete. For example, if Zone C is amended to allow for more density, in order to make multifamily housing feasible, the requirement that entrances serve no more than three units may no longer make sense (p.8). That is just one example. For that reason, we recommend that the City consider keeping these objective design standards in draft form for now, and come back to them after the Housing Element update is complete. It seems unnecessary to adopt detailed objective design standards that would be in place for only a little more than a year.

If the City decides to move forward with the standards, below are our comments on the draft document:

**Part 2: Objective Design Standards**

The proposed standards are overly prescriptive with regards to architectural design and style and will lead to excessive and unwarranted expense in multifamily construction.

Many of the provisions will increase the cost of multifamily housing without ensuring high quality design. The standards may also restrict developers from being able to utilize modular design construction strategies. While we appreciate the desire for new buildings to match the character of the existing building stock, we believe the standards hew to an overly narrow definition of architectural character, especially given the rich diversity of architecture that exists in Piedmont.

Overall, we recommend reducing the number of prescriptions and requirements to ensure that multifamily housing development will be viable. We encourage the City to solicit further feedback from local affordable housing developers and architects to understand the feasibility and impact of the design standards on affordable housing development.

Note: We understand that the City and LWC will be studying further changes to the zoning requirements for Zones C and D (such as potentially increasing allowable density, FAR, and building height, and reducing parking requirements) as part of the Housing Element process. Therefore, we are limiting our comments to feedback on the draft Objective Design Standards. In the proposed guidelines for Division 17.24 Zone C: Multi-family Residential:

1. A1a. Remove requirement for front and street side facade setback (mirroring the proposed standards for Zone D). Keep requirement for interior and rear facade setback when abutting Zone A. (p. 5)
2. B1a.i. Revise requirement that buildings have two of the following: bay windows, frequent recesses, or porches/decks--to requiring just one of these features. (p.6)
3. B1a.ii. Eliminate requirement that building facades longer than 45 feet incorporate a change in roof parapet, form, or building height (p. 7)
4. B1b. Eliminate requirement that balconies and porches be integrated into recesses or overhangs on at least one side of the porch or balcony. (p. 7)
5. B2b. Regarding the requirement that the pitch of the roof must be 3:12 to 5:12 ratio: Please clarify that flat roofs are permitted. (p. 8)
6. B2d. Eliminate prohibition on roof decks (p. 8 and 11)
7. B3a.i. Delete requirement that shared entrances may serve no more than three units. (p. 8)
8. B3b. Eliminate prohibition on external stairs to upper units. (p. 8)
9. B3c-d. Reduce prescriptions on frontage types. (p. 9) Note that the terrace frontage is inconsistent with accessible design standards. To be accessible, entrances should be level at grade.
10. B4. Eliminate requirement that ground floor finish floor elevation be 24 inches above sidewalk. This is not consistent with accessible design standards. (p. 10)
11. B5b. Revise requirement that windows be recessed from outer wall surface. (p. 10) This is not aligned with current window design and installation practices.
12. B5c. Eliminate prohibition on vinyl windows. This entails significant additional cost.
13. B5g. Eliminate requirement for "residential signifiers" (such as window bays or doors with balconies) every 10 horizontal feet. (p. 10)
14. B6c. Delete minimum requirement for private open space. (p.10) Consider increasing per unit amount of shared open space instead.
15. B7d.ii. Change maximum width of entrance to shared parking facilities to 20 feet. (p. 11)
16. C1a. Increase limit on blank walls from 8 feet to 16 feet (p. 12)
17. C2a. Why are facade materials limited to stucco stone, brick or EIFS? Why not allow wood and fiber cement siding? (p. 12)
18. C2c. Eliminate maximum percentages of secondary and tertiary colors or otherwise make building color requirements less prescriptive. (p. 12)



19. C2e. Why specify change in exterior building must occur a minimum of 8 feet beyond an outside corner? (p. 12)
20. C2i. Why are roof materials limited to composition shingle, spanish tile, or cool roof membrane in grey? Why not allow standing seam metal roofs, concrete roof tiles, or solar roofs? Also, standard white cool roof membranes should be permitted in areas where they are not visible. (p. 13)
21. C3a. Delete requirement that structural elements visible on exterior frame building apertures and modules. (p. 13)
22. C3b. Eliminate requirement that parapets exhibit a combination of steps and curves (p. 13)
23. C3d. Eliminate requirement that downspouts be concealed within building walls. (p. 13)
24. C3f. Reduce or eliminate requirement that buildings exhibit two of the following ornamental features for 15 percent of each facade: patterned accent titles, carved insets, stucco or tile decorative vents, decorative chimney top. (p. 13)
25. D2b.i. Revise requirement that landscape be planted maximum of 1 foot on center, or clarify if this is intended for ground cover, since shrubs can be planted farther apart. (p. 15)

In the proposed guidelines for Division 17.26 Zone D: Commercial and Mixed-Use:

1. A2a. Eliminate requirement that building facades longer than 65 feet incorporate a change in roof parapet, form, or building height (p. 18)
2. B1a.ii. Eliminate requirement that building facades longer than 65 feet incorporate a change in roof parapet, form, or building height (p. 18)
3. B1b. Eliminate requirement that balconies and porches be integrated into recesses or overhangs on at least one side of the porch or balcony. (p. 19)
4. B1d. Eliminate requirement for articulation of building massing at corners. (p. 19)
5. B2b. Regarding the requirement that the pitch of the roof must be 3:12 to 5:12 ratio: Please clarify that flat roofs are permitted. (p. 19)
6. B2c. Eliminate requirement for brackets, rafter tails, or beams on roofs with deep eaves (p.20)
7. B5b. Revise requirement that windows be recessed from outer wall surface. (p. 22) This is not aligned with current window design and installation practices.
8. B5h. Eliminate requirement for "residential signifiers" (such as window bays or doors with balconies) every 10 horizontal feet. (p. 22)
9. C2a. -Why are facade materials limited to stucco stone, brick or EIFS? Why not allow wood and fiber cement siding? (p. 24-25)
10. C2c. Eliminate maximum percentages of secondary and tertiary colors or otherwise make building color requirements less prescriptive. (p. 25)
11. C2i. Why are roof materials limited to composition shingle, spanish tile, or cool roof membrane? Why not allow concrete tile, solar or standing seam metal roofs? (p. 25)
12. C3b. Eliminate requirement that parapets exhibit a combination of steps and curves. (p. 25-26)
13. C3f. Eliminate requirement that buildings exhibit two of the following ornamental features every twelve horizontal feet: patterned accent titles, carved insets, stucco or tile decorative vents, decorative chimney top. (p. 26)

### Part 3 Test Massing Studies

The Zone D test massing and financial feasibility studies offer interesting and helpful analysis. However, the costs estimated in the analysis are far too low. The study assumes a land cost of \$240/sf and a construction cost of \$195/sf. In the East Bay, residential construction starts at \$400/sf. Since only one of the three test cases LWC evaluated was deemed financially feasible (and barely so), it seems that none of the test projects would be feasible. This suggests that the City will need to consider higher densities, allowable heights, reduced parking requirements, and other measures to make housing development in Zone D feasible. The financial feasibility analysis needs to be revised with higher construction costs based on credible recent sources, so that the City and LWC can develop policy recommendations that are more likely to succeed in spurring multifamily residential development. We also recommend that an analysis be done on financial feasibility using all of the state authorities pertaining to density bonuses and streamlining for affordable housing development. Finally, we note that the estimated cost of parking is too low, and that the assumption of a parking ratio of 1.5-1.7 is too high. As the City studies moves forward on its Housing Element and related zoning amendments, we encourage a shift to developing parking maximums rather than minimums, as other cities are beginning to do.

### Part 4 ADU Recommendations

Regarding the pre-approved ADU plans. In addition to the plans supplied here, we encourage the city to consider developing pre-approved plans that enable modular or kit construction. This is a step many other cities have taken, including the City of San Jose.

We generally support the recommendations for creating incentives to owners to create deed-restricted limitations on rents. These ideas include allowing two-story ADUs or an additional ADU in exchange for deed restrictions.

At the same time, we believe we need accurate data on the effectiveness of ADUs as a path to affordable housing production in Piedmont in order to create more effective policies for the future. We want to better understand whether the city's past deed-restricted ADU program (in which deed-restrictions were exchanged for parking requirement waivers) or the current affordable ADU incentive (allowing for an increase in area to 1000-1200 sf in exchange for low and very-low-income rent restrictions) succeeded in creating housing units that were rented out at affordable rates during the 10-year deed-restricted term, and after the 10-year term.

We are concerned that incentivizing ADUs at the expense of other forms of small-site housing production may reinforce some of the challenges to affordability in a city like Piedmont--for example, by gradually diminishing the stock of smaller homes and creating larger, higher-price homes out of reach to more and more homebuyers, while not significantly increasing the affordable rental housing stock (if the created ADUs are not rented out). Anecdotal evidence suggests that a fair number of ADUs built in Piedmont are not used as housing. The City collects business taxes on rental receipts and should be able to share how many ADUs in the city are being rented out. We urge the City to transparently share data on the rate of ADU production and rentals, so that it can craft effective housing production policies moving forward.

---

---

## 10/21/2021 SB 2 Community Workshop Notes

### Small Group Break-out Session Reports

**Reported by Ellen Greenberg** – clarification that the zoning map was an image of the existing zoning map. Important to confirm that there are no planned rezoning. Thoughtful comment about architectural style. Is it appropriate to lean into traditional styles? Irene referenced recent contemporary designed development on Piedmont Avenue near Mountain View Cemetery. Useful reference and example of high-quality design. We need to understand how the design standards could influence the cost of development and our ability to achieve affordability aims and affordability objectives under state law.

**Reported by David Bergman** – a lot of time with the concept of objective design standards. Intelligent question about why they need to be there. Circulate this information widely throughout the community. How is the objective standards process different from the current process. Concern about ODS being too prescriptive. Team is struggling with this question under state law. One can always go to a voluntary process as an alternative to the ODS process. Why are we only showing four stories in the site testing illustrations?

**Reported by Stefano Richichi** –Wanted more time to discuss. Residents and others had difficulty finding the public review copy of the objective design standards. Make the presentation available online. Dismayed that Zone D building envelope is subject to the existing street yard setback. Several liked the “stepbacks” to make buildings less imposing.

**Reported by Arleta Chang** – Discussion about not having a front setback for multifamily. Examples in presentation are similar to Piedmont Avenue which do not have street yard setbacks. These buildings are built right to the front property line.

**Additional comments by Maria Morga** – Height limits for Zone C and D properties that are adjacent to and close to single-family residences. Are stepbacks appropriate in these cases? Consider a difference in the height maximums between Zone C and Zone D. Consider a distinction between Grand Avenue and Civic Center height standards for Zone D.

**Reported by John Malick** – Want to point out that as a developer, the prices and rental rates are no where near the cost of construction and rental rates needed to convince someone to build in Piedmont. Min \$350 per s.f. \$3.50 per s.f. for normal rental market housing. \$3.50 per s.f. for a 9 x 20 parking space also. Feasibility analysis is off by 75% (too low). Willing to share an appraisal/proforma that is necessary to get a bank to loan.

**Reported by Mary Davis** – Questions about why the specific styles for ADUs. These are predominant styles in Piedmont. The pre-approved ADU styles do not preclude residents from building other designs so long as they meet the normal requirements (that do not specify style). Comment that ADU standards should be dependent on whether or not the ADU is visible from the street. Concerns about privacy. Concerns that current setbacks are insufficient and that the standards could include more measures to maintain privacy. Incentive to encourage renting ADUs out.

**Reported by Ian Dunn** – Where do we get these plans? When can I get them? Clarify how the height of ADUs is measured. Adapt for hillside sites. How much customization is permitted? Dimensions, roof orientation, etc? Contemporary or Modern prototype? If there are state-approved ADUs, include these as resources in the ADU incentives doc.

**Reported by Mark Hogan** – Do we really need to match the style of the existing residence? Does the pre-approved ADU need to match the existing house? Current standards are too rigid. PG&E metering and new meter is a burden. Question about is anyone looking at manufactured housing? Prototypes looks expensive to construct. How to maintain affordability longer than 10 year deed restriction? More Modern design options.

**From:** [Jane Lin](#)  
**To:** [Piedmont Is Home](#)  
**Subject:** Comments for Objective Design Standards  
**Date:** Sunday, November 20, 2022 11:16:46 AM  
**Attachments:** [Comments for ODS .JLin.docx](#)

---

**[EXTERNAL]** This email originated from an **external source**. Please use judgment and caution when opening attachments, clicking links, or responding.

To the Planning Department,

Please see my comments for Objective Design Standards in the attachment.

Thank you,  
Jane Lin

To: City of Piedmont  
Planning Department  
120 Vista Avenue  
Piedmont, CA 94611

From: Jane Lin, AIA  
104 Magnolia Avenue  
Piedmont, CA 94610

Date: November 19, 2022

Re: Comments on City of Piedmont's Multi-family Objective Standards

To: Planning Department,

I am writing to provide comments on the *multi-family objective design standards* for Zones C and D.

My name is Jane Lin, I am a licensed architect and I live in the City of Piedmont. I'm the co-chair of the Housing Advisory Committee. My work experience is writing objective standards for multi-family housing for the cities of Emeryville, San Leandro, and Union City. I presented recently to an ABAG workshop on this topic, and I am a Lecturer at UC Berkeley in the Planning Department.

First, I want to commend the City's consultants Lisa Wise Consulting and Open Scope Studio for doing a thorough job of preparing the standards. They have put together something well organized and easy to follow. My comments are about the following topics:

1. **Upper-story step-backs and privacy abutting Zone A.** It is reasonable that this is written to provide some privacy for Zone A and a sense of scale. However, it might be good to provide an objective standard for how far from the property line where they apply. Some Zone A properties are quite big, and it should be allowed, by right, to go higher than two stories before a setback incurs, if the lot is deep. This would apply to rear and interior side facades, building massing, outdoor habitable space, and balcony and deck placement. It is a recommendation to define that the rules apply within 25-feet of the property line (or more if necessary) but that further away could have design without step-backs. Step-backs are not always effective at attenuating mass and increase construction costs impeding housing production. While it's a good idea to address privacy, it should be limited to an area visible from the property line (like 25-feet).
2. **Inconsistent dimensions for articulation.** Writing objective design standards means, at times, offering minimum and maximum dimensions. From observation of the test models and illustrations, I am concerned that the following numbers are too big. It

would be good to find out how frequently we see these dimensions in Piedmont and tune them back a little, since they are not what seems to be consistent with existing patterns in Zone C and D.

- a. Massing breaks, minimum 6 feet deep (horizontal). Recommending less.
  - b. Window bays, minimum of 2 feet deep and 3 feet deep for mixed-use (horizontal). Recommending less.
  - c. Recesses, minimum 3 feet deep for mixed-use (horizontal). Recommending less.
  - d. Change in parapet, minimum 6-feet (vertical). Recommending less.
  - e. Change in building height, minimum 8-feet (vertical). Recommending less.
  - f. Please check that the graphic matches the Ground Floor Finish Floor Elevation. 18" is preferred to 24" (page 10).
3. **Retail/Commercial Standards.** It is my experience working with commercial brokers that the commercial standards as written now would lead to empty spaces. Mixed-use on Grand and Highland would be amazing, but it is really challenged. The mixed-use housing market is driven by the design of the housing units and not the retail so it is imperative for the City to regulate the design of commercial spaces better, otherwise it will not result in successful commercial uses. It would be ideal if:
- a. Arcades are discouraged for visibility reasons. Storefronts do not typically have arcades in front of them in our area.
  - b. Awnings are a good idea, but why so prescriptive about where they project out to (minimum is ok, why a maximum)?
  - c. Ground floor height is too low at 12 feet minimum to be leasable. It is preferable to require 16 feet minimum floor to ceiling interior to make it more leasable. If this is starting to run into the height limit, perhaps provide a bonus or incentive for including commercial which is a very challenged land use.
  - d. Ground floor leasable commercial space should have a minimum depth of 50 for 50% of the space *or a minimum of 30-feet width, whichever is bigger.*
4. **Over-prescriptive standards.** Some standards seem unnecessary and forced from a particular "style."
- a. It is not necessary to regulate Bay Articulation and Arcade columns with such great detail. Recommending, editing back some of this section such as requirements for which bays are higher than others, or the spacing of columns.
  - b. The method of selecting from a menu of options is preferred.
  - c. Also corners do not need to be regulated with a "tower" but should be regulated to wrap so that the primary treatment wraps around the corner to not appear pastiche by applying the same treatment for 10 to 20 feet on side facades.
  - d. Roof decks. Why are they limited to a maximum of 30 percent of the building footprint? Isn't it nice to have this amenity? In my experience, the roof deck is already subject to other constraints like rooftop equipment. Why regulate the size at all?
5. **Blank Walls.** It would be good to regulate building side-facades differently from front-facades. It is realistic to imagine a side wall to be blank, so enhancements are a good idea.

- a. Not sure what a “water table”, “string course” or “horizontal cornice” is, it would be helpful to define further because these could be seen as subjective. Maybe add to terms at the end?
  - b. Could a mural be ok on blank walls? Perhaps consider adding this to the list of options.
- 6. Building Materials.**
- a. Primary Building Materials. It is my experience that other cities ban EIFS panels because it is perceived as a cheap and environmentally detrimental material. Why would EIFS be allowed in Piedmont?
  - b. Roof Materials. Why is Timberline Lifetime Architectural called out? Is this a branded product? Why not other options?
  - c. Walls and fences. Consider also requiring some consistency for materials for perimeter fencing.
7. **Landscape.** “Landscaping shall be placed according to sunlight needs.” This standard seems open to interpretation and could use a revision.
8. **Entrances.** Why is there a maximum of entrances for mixed-use buildings? The more ground floor entrances the more activity flows to the street. Recommending removing a maximum of 2 entrances in Zone D.
9. **Long-term Bicycle parking.** It would be great if long-term bicycle parking was strengthened to accommodate long-tail and support the use of electric bicycles. This would mean requiring dimensions for long-tail bikes and outlets near bicycle racks for e-bikes. It would also be great if the requirement is not for showers, but for automatic doors with security, air pumps, and lockers in bicycle rooms.
- a. The bicycle and auto parking clearance is confusing, x-feet of *vertical* clearance? Or do you mean horizontal?
10. **Short-term bicycle parking.** Short-term bicycle parking is on the sidewalk. Consider revising away from requiring a percent, but instead use a dimension like 1 short term bicycle parking rack is required within 20 feet of all building entrances, spaced 20 feet apart if there are many entrances.

Generally, these standards are consistent with what other communities in the East Bay are doing. It is my hope that some of the comments above are considered as small adjustments, and that the City continues to move forward in preparing for more multi-family and mixed-use housing! Thanks for all your work on this.

Sincerely,  
Jane



**Pierce Macdonald**

---

**From:** Lisa Joyce <lisajoyce@sbcglobal.net>  
**Sent:** Tuesday, November 22, 2022 10:17 AM  
**To:** Pierce Macdonald  
**Subject:** Re: Multi-family Objective Design Standards

**Follow Up Flag:** Follow up  
**Flag Status:** Flagged

[EXTERNAL] This email originated from an **external source**. Please use judgment and caution when opening attachments, clicking links, or responding.

Thanks Pierce.

One question of clarification when you get a chance - I know that affordable housing cannot be subjective to design review - so my comment about that would not apply. But are these standards to apply to any multi-family housing proposed in the city? And would those be subject to design review? How might projects that have some of both be handled?

Thanks also to you and your colleagues for all the work you have done on the housing element. I have appreciated the outreach efforts and find the website very informative.

Have a Happy Thanksgiving ~

Lisa

---

Lisa Joyce **Architecture**  
1416 Grand Avenue  
Piedmont, CA 94610

Mobile: 510.541.2661  
Office/fax: 510.653.2116  
[lisajoyce@sbcglobal.net](mailto:lisajoyce@sbcglobal.net)

[http://www.houzz.com/pro/ljarch/\\_public](http://www.houzz.com/pro/ljarch/_public)

On Nov 22, 2022, at 9:01 AM, Pierce Macdonald <[pmacdonald@piedmont.ca.gov](mailto:pmacdonald@piedmont.ca.gov)> wrote:

Thank you, Lisa. We will review your comments.

---

**From:** Lisa Joyce <[lisajoyce@sbcglobal.net](mailto:lisajoyce@sbcglobal.net)>  
**Sent:** Monday, November 21, 2022 6:03 PM  
**To:** Piedmont Is Home <[piedmontishome@piedmont.ca.gov](mailto:piedmontishome@piedmont.ca.gov)>  
**Subject:** Multi-family Objective Design Standards

**[EXTERNAL]** This email originated from an **external source**. Please use judgment and caution when opening attachments, clicking links, or responding.

Over the past several weeks I have looked at the proposed standards several time. Each time I come away with the same reaction - they are overwhelming and excessively detailed.

As both a resident of Grand Avenue (where multi-family housing might - and should - be developed) for 33 years and as an architect who specialized in multi-family affordable housing early in my career, I am very interested in the proposed standards. Design standards are difficult to develop as they can be followed to the letter and still result in mediocre or even bad building design because excessive standards squelch creativity. (Kind of like telling Picasso he can only paint in the style of Da Vinci!)

In a nutshell, the design standards as written work against both good design and reasonable construction costs. The following are just a few examples of this:

Mitigate against good design by being overly prescriptive

The guidelines seem to be based on one successful building type; in reality there are many. These guidelines hamper the ability of the architect to develop an appropriate overall design that suits the site, the client, and the future occupants. While Piedmont's housing stock is mostly traditional in style - there can be successful multi-family housing built that is modern in style.

Discourage development of affordable housing by increasing costs both in design time and construction

Some of the provisions show a lack of understanding of how buildings are built. For example, the requirement to have all windows recessed at least 2" from the face of the finish requires significant additional labor to achieve. Incorporating these numerous requirements will also add cost for design time AND the work of city staff to confirm they are all met.

Apply standards to future residents of these dwellings that do not apply to current Piedmont residents

For example, there is a requirement that roof decks, if provided, must not allow "...the deck or the deck occupants to be visible from ....adjacent single-family property within 300 feet." Yet throughout Piedmont there are many decks visible to the adjacent single-family properties. Due to our local topography, some of the decks are often so close neighbors can reach across to each other!

I looked back at both the work of my former partner, Sam Davis (who has both won awards for and written books about affordable housing design) as well as the recent work of other award-winning Bay Area housing architects such as David Baker Architects and Michael Pyatok Architects. Most of the attractive and successful projects these renowned architects have designed would not meet the design guidelines as written.

In my experience designing affordable housing, we presented our projects to the local government bodies and explained and defended our design work. Adjustments and compromises were made to assure the goals of the city and the local neighborhood were also met. Can these standards be streamlined, knowing the designs will ultimately be subject to design review?

I suggest that the city invite some local architects with multi-family and affordable housing design experience to provide their insight on what might constitute reasonable design guidelines to achieve the City's goals but not hamper good design or increase construction cost unnecessarily.

Thanks for the opportunity for input.

Lisa Joyce

---

Lisa Joyce **Architecture**  
1416 Grand Avenue  
Piedmont, CA 94610

Mobile: 510.541.2661  
Office/fax: 510.653.2116  
[lisajoyce@sbcglobal.net](mailto:lisajoyce@sbcglobal.net)

[http://www.houzz.com/pro/liarch/\\_public](http://www.houzz.com/pro/liarch/_public)

Irene Cheng  
135 Sunnyside Avenue  
Piedmont, CA 94611

November 22, 2022

City of Piedmont  
Planning Department  
120 Vista Avenue  
Piedmont, CA 94611

**Re: Comments on City of Piedmont's Multi-family Objective Standards**

Dear Piedmont Planning Department:

I am writing to offer feedback on Piedmont's latest draft Multifamily Objective Design Standards (MODS). I am a resident of Piedmont, design professional, and professor of architectural history at the California College of the Arts. My academic specialization is nineteenth-century American architecture, including Arts and Crafts design, but I have a deep appreciation of a range of architectural styles.

I appreciate the numerous changes that have been made in the current draft, incorporating feedback that I and others gave the City last fall. The current document is improved from the previous version. However, I continue to find the current MODS overly restrictive, complicated, aesthetically conservative, and stylistically subjective. Many of the measures impose excessive costs on new multifamily development and are so out of line with best practices in present-day multifamily housing design that they would likely discourage market-rate development, and effectively make the construction of affordable housing meeting the MODS impossible.

However, my primary objection to the MODS is that they will not contribute to creating high-quality design and, in fact, are likely to produce just the opposite. As someone who has practiced or taught architectural design for twenty years, I can attest that excessive requirements for variation in facade treatment, rooflines, and other ornamental treatments often lead to over-complicated, cacophonous, and unsightly architectural design. The MODS seem targeted to create one particular style of architecture: The faux-Mediterranean-historicist II Piemonte building on Piedmont Ave is the favored model. In contrast, most of the guidelines would disallow a more modern style of architecture such as the Amador apartments just up the street. Both of these works of architecture are high-quality and within Piedmont's orbit—and hence contextual. Within its borders, Piedmont has examples of both historicist

(Mediterranean, Craftsman, and more) and modern/contemporary architecture. So why is one style being favored in the new “objective” design guidelines?



Il Piemonte (left) and the Amador (right) - two mixed-use multifamily buildings on Piedmont Ave.

To return the MODS to an objective basis, I ask that the City remove or revise the following standards, which are aesthetically arbitrary and unnecessary:

B.1. (p.6 and 18-19) Eliminate or reduce requirements for window bays or recesses to enable more modern, less cluttered facade designs.

B.1.a.ii and B.2.a.iv. (p.6, 18-19) and C.3.b. (p.26) Delete the requirement for changes in roof parapet height, roof form or building height. Roofs should be allowed to have clean, straight lines without decorative jogs. This standard has no objective basis and essentially disallows modern building styles.

B.5.d. (p.10 and 22) Remove requirements that 50 (in multifamily) or 100 percent of residential (in mixed-use developments) windows must have divided lite design. Divided lites are not consistent with modern architectural styles. There is no objective basis for this requirement.

C.3.e. (p.13-14) and C.3.cii (p.27) Delete the requirement that buildings exhibit TWO ornamental features for “over 15% or more of each facade.” Requiring buildings to have patterned accent tiles, carved insets with grilles, stucco or tile motifs, or terra-cotta tile chimney top will produce schlocky ornamented facades. This standard has no objective basis and will actually have a very negative design impact, in my view.

In addition, I strongly recommend revision of the following standards:

A.1.a. (p.5 and 17) Remove requirement for 5 foot stepback along front and street side facade to allow for more continuous facade designs, up to 4 stories. Stepback above four stories may be fine.

A.4.a and b. (p. 6 and 17) Change the prohibition on balconies and decks abutting single-family uses in Zone A on upper story facades or roofs, and the requirement that they be oriented toward street yards. This will bar roof decks from most of the most promising multifamily sites in Piedmont, most of which abut single-family parcels in Zone A. Roof decks are desirable features, and will help multifamily buildings meet the open space requirements specified elsewhere in the MODS. We should not make them effectively impossible to incorporate.

B.3.c. (p. 8) Do not require recessed forecourts, or reduce dimensions.

B.4. (p. 10) Eliminate requirement for ground floor finish floor elevation to be 18 inches above the sidewalk elevation. This will make it more expensive to meet accessibility requirements.

B.1.a.c. (p. 18) Reduce specification for porches or decks over a minimum of 25 percent of the facade to 15 percent. The 25% guideline may be hard to meet, especially given the restrictions on decks in other parts of the document.

B.2.a.v. (p. 7 and 19) The standard allows roof decks that are enclosed, "provided the deck and deck occupants are not visible from the right-of-way or adjacent single-family property within 300 feet." This requirement will disallow roof decks in a large proportion of parcels. For example, most of the mixed-use parcels on Grand Ave abut properties on Olive that sit high above Grand. It may be impossible to put a roof deck on a building on Grand that is not visible to neighbors on Olive Ave. The same condition exists on Linda Ave, with respect to neighbors on Sunnyside Ave. See comment to A.4. above.

B.2.e. (p.19) Please remove limitation on roof decks to a maximum of 30 percent of a building footprint. See comments to A.4 and B.2.a.v. above.

C.2.a.(p. 12 and 25) Add fiber cement siding as an allowed primary cladding material. Fiber cement siding (for example, Hardie board) is commonly used on small multifamily buildings in our area, and is higher quality than EIFS, which is listed as an allowed primary cladding material.

As the City moves forward to encourage multifamily housing production, it is important that we get these design guidelines right. I urge the City to revise the MODS to be truly objective and able to give rise to high-quality, urbanistically sensitive architecture in a variety of styles. Thank you.

Yours truly,



Irene Cheng



# City of Piedmont

## Multifamily Objective Design Standards

Planning Commission Meeting | June 12, 2023



# Multifamily Objective Design Standards (MODS)





# Multifamily Objective Design Standards (MODS)

Objective design standards are defined in Government Code Sections 65913.4 and 66300(a)(7) as standards that:

*“involve no personal or subjective judgment by a public official and are uniformly verifiable by reference to an external and uniform benchmark or criterion available and knowable by both the development applicant or proponent and the public official before submittal.”*

Objective design standards may include portions of general plans, specific plans, zoning codes, overlay zones, subdivision requirements, and landscaping and other land development regulations.



# What are Piedmont MODS?



State laws, including SB 35 and SB 330, require cities to have objective design standards, rather than discretionary ones, for multifamily and mixed-use multifamily developments. The Piedmont MODS were developed to:



- Enhance community character in Zone C and Zone D.
- Establish objective criteria to evaluate development proposals.
- Respond to community preferences for building designs, materials, roof forms, windows, entrances, lighting, and other features.
- Establish design standards that lead to development that the community supports.
- Ensure predictability in design and review (preserve local control).
- Implement Housing Element Program 4.R, Permit Streamlining.



# Zone C and D Locations



## ZONING

-  Zone C: Multi-family residential
-  Zone D: Commercial and mixed-use commercial/residential

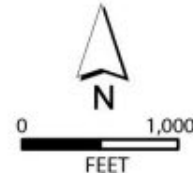

# MODS Public Outreach and Engagement

- **November 2020** - Stakeholder interviews, 34 community members.
- **March 2021** - Piedmontishome.org website, FAQs, and online housing survey. Survey included questions on design preferences.
- **May 19, 2021** - Housing Advisory Committee public presentation on the Piedmont community's multifamily design preferences
- **June 15, 2021** - Housing Advisory Committee public presentation.
- **June 21, 2021** - City Council meeting on Guiding Principles.
- **September 19, 2021** – Piedmont fair housing pop-up booth at the Piedmont Harvest Festival 2021.
- **October 21, 2021** - Community workshop on the Zoom platform and the publication of the draft of the MODS document.
- **November 8, 2021** – Planning Commission presentation.
- **October 19 to November 19, 2021** – Public comment period.
- **March 15, 2022** – Housing Advisory Committee presentation.
- **October 10, 2022** – Planning Commission presentation.
- **March 20, 2023** – City Council adoption of 6<sup>th</sup> Cycle Housing Element.

Per State law, California cities:

- **Must provide streamlined approval** for qualifying affordable housing developments.
- **May not impose new subjective design standards** on residential developments.
- **Must support and actively facilitate** affordable multi-family development on sites between 0.5 acres and 10 acres in size that permit residential uses at a density of at least 20 du/ac.





## SB 2 New Housing Programs Guiding Principles, adopted June 2021

- 1. Support equitable distribution of affordable units across the City.** A diversity of housing choices, including new affordable multi-family housing, new mixed-income multi-family housing, new residential mixed-use development, converted units, ADUs, and Junior ADUs, should be considered throughout the City's neighborhoods, corridors, and zoning districts.
- 2. Promote and enhance community design and neighborhoods.** Infill development should be compatible with the neighborhood context. Development and design standards should ensure that new construction enhances the area in terms of building scale, placement, and design; and is sensitive to impacts on the neighborhood, including impacts related to sunlight access, privacy, and roadway access. Each building must exhibit high-quality design and play a role in creating a better whole.
- 3. Remove barriers to development and access to housing through clear and objective standards.** Development standards and procedures should guide development that is equitable and feasible and that lead applicants through procedures that are transparent and predictable.



## SB 2 New Housing Programs Guiding Principles (continued)

**4. Facilitate the development of new housing units through strategic partnerships between the City and the broader community.** Partnerships to facilitate development include striving to reach community consensus for desired designs; and achieving community support for new incentives, standards, and tools to meet housing goals.

**5. Social equity.** Work with the Community to proactively facilitate greater social equity by considering City incentives and programs that will enable new homes and apartments for a range of income levels, creating opportunities for all persons regardless of race, religion, ethnic background, or financial ability.





# Local Multifamily Housing Examples





## Multifamily Objective Design Standards

- Acknowledge existing patterns of development and ensure that development enhances Zone C and Zone D neighborhoods.
- Reflect the community's design priorities and be consistent with Piedmont Design Guidelines
- Promote development in a generally preferable design.
- Projects that comply with the Code's objective design standards may undergo administrative review only; projects that do not may voluntarily choose a discretionary Design Review process.

Piedmont MODS published October 6, 2022. Publicity included Citywide newsletter and press release to local news outlets.

Public review and comment was October 6 to November 21, 2022.

Comments can be sent to **[Piedmontishome@piedmont.ca.gov](mailto:Piedmontishome@piedmont.ca.gov)**

- Excellence in design
- Sensitive site planning
- Neighborhood compatibility
- Predictable and high-quality design

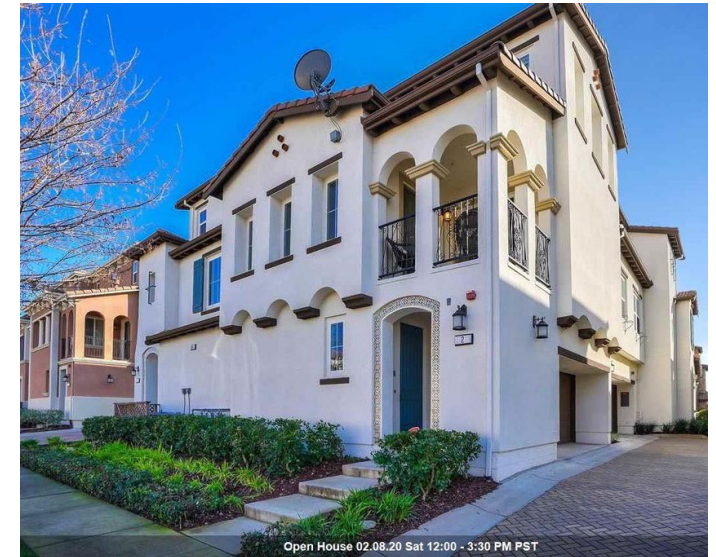



# MODS Contents

## A. Building Envelope Design

1. Upper-story Step-backs
2. Building Placement
3. Building Massing Abutting Zone A
4. Privacy

## B. Building Design

1. Street-facing Building Articulation
2. Roof Form and Design
3. Building Entries
4. Ground Floor Finish Floor Elevation
5. Window and Door Design
6. Residential Unit Design
7. Parking and Driveway Design
8. Equipment Screening
9. Additions and Remodels

## C. Façade Design

1. Blank Walls
2. Building Materials, Colors, and Finish
3. Architectural Details
4. Additions and Remodels

## D. Site Design

1. Walls and Fences
2. Landscaping
3. Site Circulation
4. Refuse and Recycling Areas
5. Lighting
6. Energy Efficiency
7. Parking Reductions (Zone D)



Design Element	Zone C	Zone D
Entry types	Shared forecourt, Shared or individual covered terrace, Individual covered dooryard, and Individual covered stoop	Covered shopfront, Covered terrace, and Covered arcade

### Shared forecourt

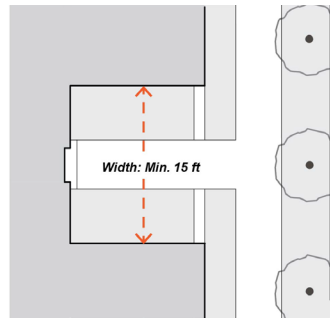

### Individual covered stoop

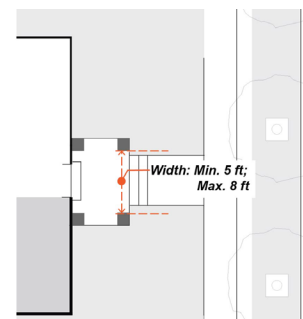
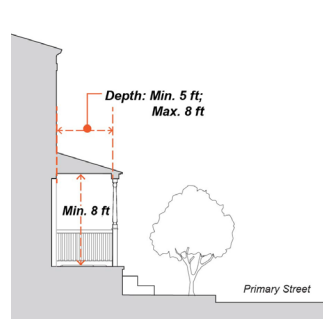

### Individual covered dooryard

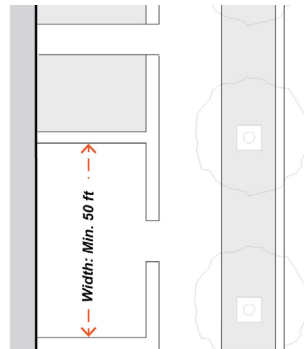
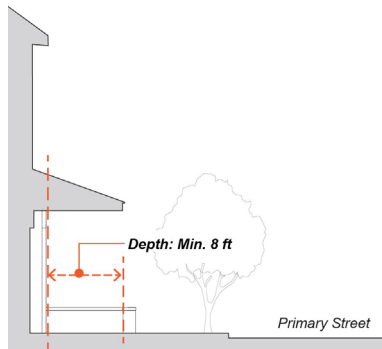

### Covered terrace

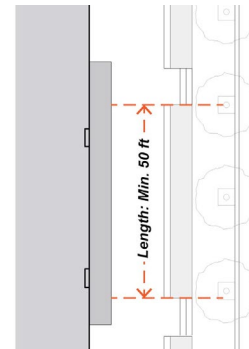
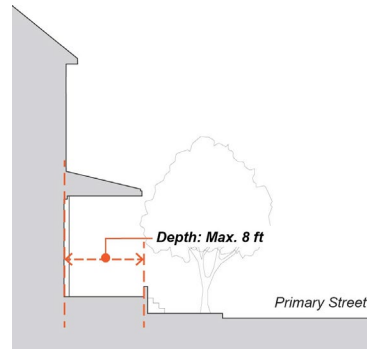

Design Element	Zone C	Zone D
<b>Landscape Design</b>	<ul style="list-style-type: none"> <li>• Must be native, low-water usage, low maintenance, placed according to sunlight needs and to provide shade in south-facing and west-facing areas</li> <li>• Must meet MWEL0 requirements.</li> <li>• Existing mature trees preserved and incorporated as part of the overall design.</li> </ul>	
<b>Frontage Landscaping</b>	<ul style="list-style-type: none"> <li>• Required street setback area, excluding areas for ingress/egress, must be landscaped.</li> <li>• May include container plantings, groundcover, turf, climbing vines, shrubs, low hedges, trees.</li> <li>• Max. 20% of the required front setback area may be turf.</li> </ul>	<ul style="list-style-type: none"> <li>• <i>Civic Center Subarea:</i> Planter beds, window boxes, and/or container plantings required at all façade insets, niches, entries.</li> <li>• <i>Grand Avenue Subarea:</i> Required street setback area must be landscaped except for seating areas, on-site plazas, and areas of ingress and egress. May include container plantings, planter beds, groundcover, climbing vines, shrubs, low hedges, trees.</li> </ul>
<b>Hardscape Materials</b>	Permeable or pervious, light in color, a high solar reflective index.	
<b>Paving within Setback Area</b>	<ul style="list-style-type: none"> <li>• Plazas or outdoor seating areas must be separated from the sidewalk by landscaping, raised planters, or similar features.</li> <li>• Paving must be visually distinct different from the adjacent public sidewalk and consist of individual paving blocks.</li> </ul>	
<b>Curb Cut Frequency</b>	Max. 1 per street frontage per lot.	



# Next Steps –

- ❖ City staff expects to bring forward a recommendation for the draft Multifamily Objective Design Standards (MODS) and ADU incentives in July 2023. New standards and incentives will be amendments to the Piedmont Design Guidelines (to be retitled “Piedmont Design Standards and Guidelines.”)
- ❖ City staff requests Planning Commission consideration of possible information or revisions that may be required so that the Planning Commission can make a recommendation to City Council.
- ❖ MODS and ADU incentives are expected to be heard by City Council later this summer.



# Contact

[piedmontishome@piedmont.ca.gov](mailto:piedmontishome@piedmont.ca.gov) or

Visit

[Piedmontishome.org](http://Piedmontishome.org)

CITY HALL





## PIEDMONT PLANNING COMMISSION

Regular Meeting Minutes for Monday, October 10, 2022

A Regular Session of the Piedmont Planning Commission was held on Monday, October 10, 2022, both in person and via ZOOM teleconference, in accordance with Government Code Section 54953. The agenda for this meeting was posted for public inspection on September 26, 2022, in accordance with the General Code Section 54954.2 (a).

- CALL TO ORDER** Chair Rani Batra called the meeting to order at 5:30 p.m.
- ROLL CALL** Present: Chair Rani Batra, Commissioners Yildiz Duransoy, Jonathan Levine, Tom Ramsey, Douglas Strout, and Justin Zucker
- Absent: None
- Staff: Planning & Building Director Kevin Jackson, Senior Planner Pierce Macdonald, Associate Planner Gopika Nair, Assistant Planner Steven Lizzarago, Assistant Planner Joshua Muller, and Administrative Assistant Mark Enea
- PUBLIC FORUM** There was no **public testimony**.
- REGULAR SESSION** The Commission considered the following items of regular business.
- APPROVAL OF MINUTES** **Resolution 23-PL-22**  
RESOLVED, that the Planning Commission approves as presented its meeting minutes of the September 12, 2022, regular meeting of the Planning Commission.  
Moved by Ramsey, Seconded by Levine  
Ayes: Batra, Duransoy, Levine, Ramsey, Zucker  
Noes: None  
Abstain: Strout  
Absent: None
- CONSENT CALENDAR** There were no items placed on the Consent Calendar.
- REGULAR CALENDAR** The Commission considered the following items as part of Regular Calendar:
- Housing Policy Updates** Planning & Building Director Kevin Jackson and Senior Planner Pierce Macdonald presented an update on the development of fair housing policy, including Piedmont's 6th Cycle Housing Element, recent new State of California Legislation (2022), and a new program to establish multi-family objective design standards (MODS) for development in Zone C and Zone D.
- City staff members are developing new housing policy in compliance with State law and regional affordable housing programs:
- Draft 6<sup>th</sup> Cycle Housing Element
  - ADU Incentives
  - Measure A-1 Affordable Housing Bond
  - Multifamily Objective Design Standards (MODS)
  - SB 9 ministerial review of housing up to 4 units in single-family zone
- Director Jackson informed the Commission that there were 41 separate bills signed by Governor Newsom that are related to housing this session.

Of these bills, he provided a brief description of a few bills that might most affect land use in Piedmont: SB 897 and AB 2221, which affect accessory dwelling unit regulations; AB 916 and AB 2097, which limit parking requirements; AB 157 and other bills that facilitate funding for ADUs; AB 682 and AB 2334, which modify density bonus laws; AB 2011 and SB 6, which facilitate the development of housing in commercial zones; AB 1743, which expands the data required to be submitted in annual progress reports; AB 2234, which increases requirements for the processing of post-entitlement (building) permits; and AB 2339, which is meant to streamline the processing of permits for emergency shelters. Director Jackson concluded his presentation by answering a few clarifying questions from Commissioners.

Senior Planner Pierce Macdonald provided a presentation on objective design standards, stating that State laws, including SB 35 and SB 330, require cities to have objective design standards for multifamily and mixed-use multifamily developments. The draft Piedmont MODS were developed to:

- Enhance community character in Zone C and Zone D.
- Establish objective criteria to evaluate developmental proposals.
- Respond to community preferences for building designs, materials, roof forms, windows, entrances, lighting, and other features.
- Establish design standards that lead to development that the community supports.
- Ensure predictability in design and review (preserving local control).
- MODS are not part of the Housing Element update process.

Under an SB 2 grant, the City's housing staff and consultants, have prepared a proposed new housing program in compliance with State law consisting of objective design standards for multifamily and mixed-use development (MODS). A second new housing program to develop new incentives for rent-restricted ADUs was also funded by the SB 2 grant. The ADU incentives program will be presented at a future Planning Commission meeting. The SB 2-funded work began in the fall of 2020 with City Council authorization.

The SB 2 new housing programs guiding principles, adopted in June 2021, direct the City to support equitable distribution of affordable units across the city, to promote and enhance community design and neighborhoods, to remove barriers to development and access to housing through clear and objective standards, to facilitate the development of new housing units through strategic partnerships between the City and the broader community, and to further social equity.

The Piedmont's draft MODS were published on October 6, 2022. The publicity includes the Citywide newsletter and press release to local news outlets. Public review and comment will have a minimum of 45 days ending on November 19, 2022. Comments can be sent to [Piedmontishome@piedmont.ca.gov](mailto:Piedmontishome@piedmont.ca.gov).

The content of the MODS include building design, façade design, and site design. The next steps for all housing programs are as follows:

- MODS public comment period is October 6, 2022 through November 19, 2022.
- City staff members expect to bring forward draft multifamily objective design standards (MODS) and ADU incentives in late 2022 or early 2023.
- Draft Housing Element is expected to return to City Council later this year. City Council will consider a resolution directing City staff to submit the

revised Draft Housing Element to HCD to start its 90-day review. Comments from HCD are expected by February 2023.

- The deadline for a Measure A1 application continues to be December 2024.
- New subdivision standards and objective design standards are necessary for SB9 implementation are also planned for late 2022 or early 2023.

In response to Commissioners Ramsey and Duransoy, Mr. Jackson stated the objective design standards are meant for the development of new housing rather than a remodel of an existing building. Historic preservation is addressed when the existing building will be demolished. For SB 9 development applications, new objective design standards will need to be created for single-family residential, duplexes and others.

There was no **public testimony**.

**Fence Design Review Permit,  
89 Sea View Avenue  
DRFW 2022-016**

The Property Owners are requesting permission to construct an entry gate and columns within the 20-foot street-yard setback.

**Public testimony** was received from:

Matthew Mosey, architect, stated they updated the design for the front yard gate. The existing siding of the house is below street level. The gate would create a filtered view across the private-public threshold. The entryway would create a visual marker off the entrance of the sidewalk.

Commissioner Duransoy stated that gates in front yard should be avoided and does not support the design. Commissioner Levine also does not support the design and stated it is not consistent with design guidelines.

Commissioner Ramsey stated there are unique characteristics to the site, including the house being unusually close to the street, it is two feet below sidewalk grade, the existing walls run the entire length of the house, and the gate is 80% open and will tie into the renovation of the home. Commissioners Strout and Batra agreed with Commissioner Ramsey in support of the project.

**Resolution 016-DRFW-22**

WHEREAS, the Property Owners are requesting permission to construct an entry gate and columns within the 20-foot street-yard setback, which construction requires a design review permit, and,

WHEREAS, after reviewing the application, plans, and any and all testimony and documentation submitted in connection with such application and after visiting the subject property, the Piedmont Planning Commission finds that the project is categorically exempt under the California Environmental Quality Act, CEQA, pursuant to CEQA Guidelines Section 15303, Class 3 (e) New Construction or Conversion of Small Structures, the project is consistent with General Plan policies and programs, and the proposal, as conditioned, conforms to the criteria and standards of Section 17.66.060 of the Piedmont City Code as follows:

1. The proposed design is consistent with the City's General Plan and Piedmont Design Guidelines. The following building features are consistent with the original architecture and neighborhood development including the steel gate and porcelain tile plinth materials, the open gate design, and the height of the plinths and gate is consistent with the design guidelines for front yard fencing.